

Catalogue

Woodworking

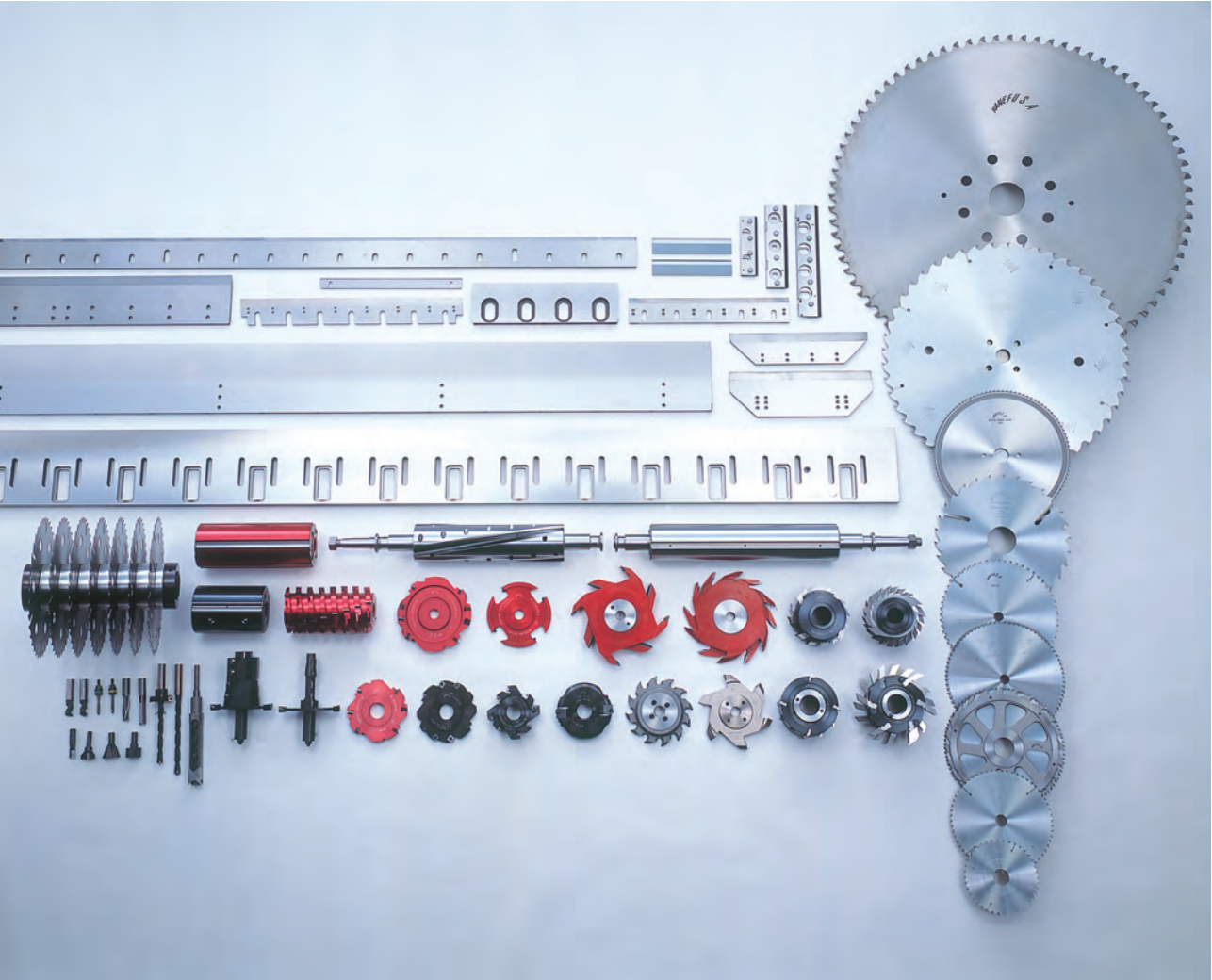



Kanefusa is Japan's largest manufacturer of high quality industrial tools used in the woodworking, metalworking, paper and plastic processing industries.

Kanefusa was established as a company in 1896 and since then it has always been our strategy to continuously develop new products and cutting techniques to achieve one goal:

Higher User Value

Our saw blades, cutters and machine knives are engineered to the highest industrial standards and satisfied users all around the world testify to the reliability of our products.

Today we have over 1000 employees working at 3 production sites and in 12 domestic and 8 international offices.

Our Customers



Primary Woodworking

- Sawmills
- Plywood & Veneer Manufacturing
- Particleboard, MDF, HDF & OSB Manufacturing
- Solid Wood Panel Manufacturing etc.



Solid Wood Processing

- Planing Mills
- Truss and Beam Manufacturing
- Window and Door Manufacturing
- Staircase Manufacturing
- Furniture Manufacturing
- Chair and Upholstery Manufacturing
- Parquet Floor Manufacturing
- Composite Floor Manufacturing etc.



Panel Processing

- Kitchen & Bath Room Furniture Manufacturing
- Furniture Component Manufacturing
- Laminate Floor Manufacturing
- Exterior and Interior Door Manufacturing etc.



Craftsmen

- Carpenter
- Cabinet Maker
- Installer etc.

Contents

1 Sawing



Solid Wood

Timber Max <i>Heavy Duty Rip Saw Blade</i>	9
Timber Max TK <i>Thin Kerf Splitting Saw Blade</i>	13
Tough Black <i>Saw Body Coating</i>	15
SF-Saw Blade <i>Glueline Saw Blade</i>	17
Yield Pro <i>Fine Cross Cut Saw Blade</i>	19

Board Materials

Board Pro III D-Type <i>Heavy Duty Panel Sizing Saw Blade</i>	21
Board Pro III TD-Type <i>Finish Cut Saw Blade</i>	25
Board Pro D-Type <i>Panel Sizing Saw Blade</i>	27
Board Pro BC-Type <i>Panel Sizing Saw Blade</i>	31
Board Pro Scoring <i>Scoring Saw Blade</i>	33
Eco Saw Blade <i>Hollow Face Panel Sizing Saw Blade</i>	39
Board Pro Plus <i>Finish Cut For Table Saw Blade</i>	41
Table Saw Blade <i>Finish Cut Saw Blade</i>	43
DIA V-tech <i>Finish Cut Panel Sizing Saw Blade</i>	45
Board Pro DIA <i>Heavy Duty Panel Sizing Saw Blade</i>	47

Non-ferrous Metals

Sash Pro <i>Heavy Duty Saw Blade</i>	51
Stable Saw Blade <i>Thin Kerf Saw Blade</i>	53

2 Finger Jointing



Structural Joints

TAF-Pro <i>HS-HP tipped Type Finger Joint Cutter</i>	57
TAF-C <i>HS-HP Finger Joint Cutter Head</i>	59
Micro Finger Joint Cutter Head <i>HS-HP tipped Type Finger Joint Cutter</i>	61

Millwork Joints

Disc Type Cutter <i>HC-UP tipped Cutter</i>	63
--	----

3 Planing



ENSHIN <i>Self-Locking Planer Head</i>	67
ENSHIN PowerLock-Type <i>Self-Locking Planer Head</i>	69
ENSHIN <i>Blades</i>	71
ENSHIN <i>Reference Engraver</i>	73
Planer Head with αMT coated inserts	75
Tersa[®]-System <i>Blades</i>	77
ST-1 <i>Planer Knives</i>	79
ST-1 Planer Head <i>Hydro Planer Head</i>	83

4 Profiling



ST-1 <i>Corrugated Back Knives</i>	89
ST-1 Knife Head <i>PowerLock Type</i>	91
SF-Splitting Technology <i>HC-UP tipped Cutter</i>	93
SF-Tongue and Groove Cutter <i>HC-UP tipped Cutter</i>	95
SF-Radius and Chamfer Cutter <i>HC-UP tipped Cutter</i>	97
SF-Panel Raise Cutter <i>HC-UP tipped Cutter</i>	99
SF-Profile Cutter <i>HC-UP tipped Cutter</i>	101

5 Routing



E-Bit <i>Solid HC-UP Bit</i>	105
SF-Router Bit <i>HC-UP tipped Router Bit</i>	107
Acryl-Bit <i>Mirror Finish Router Bit</i>	111
Cosmo-Bit <i>PCD tipped Router Bit</i>	113

Contents

6 Carpentry



Brad Point Drill Bit	_____	117
ACE Counterbore Drill Bit	_____	118
Pre Cut Tooling	_____	119

7 Accessories

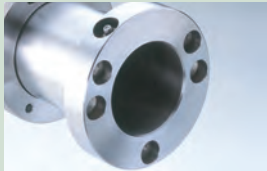

Hydraulic Precision Chuck <i>CNC-Router Machine</i>	_____	123
Hydro Mechanical Precison Chuck <i>CNC-Router Machine</i>	_____	123
Hydro Tool Holder <i>Powermat</i>	_____	125
Tool Holder <i>Powermat</i>	_____	125
Hydro Sleeve	_____	127
Locking Ring <i>Safety Part</i>	_____	127

8 Industrial Knives

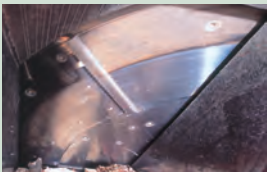

Plywood Knife <i>Veneer Knife</i>	_____	135
Clipper Knife <i>Veneer Knife</i>	_____	135
Timber Tec <i>Chipper Knife</i>	_____	136
Flaker Knife <i>Chipboard & OSB Production</i>	_____	137

9 Company Profile



Business Activities	141
Global Network	143
Quality	145
History	147

10 Technical Information



Saw Blade Technology	151
Thin Sawing Technology (TST)	152
Advanced Material Technology	153
PCD Fusion Technology (V-tech)	154
TAF-C Finger Joint Knives	155
General Technical Information	156
Cutting Edge Materials	160
Saw Blade Specifications	161
Tooth Geometries	162

Solid Wood

Timber Max <i>Heavy Duty Rip Saw Blade</i>	9
Timber Max TK <i>Thin Kerf Splitting Saw Blade</i>	13
Tough Black <i>Saw Body Coating</i>	15
SF-Saw Blade <i>Glueline Saw Blade</i>	17
Yield Pro <i>Fine Cross Cut Saw Blade</i>	19

**Board Materials**

Board Pro III D-Type <i>Heavy Duty Panel Sizing Saw Blade</i>	21
Board Pro III TD-Type <i>Finish Cut Saw Blade</i>	25
Board Pro D-Type <i>Panel Sizing Saw Blade</i>	27
Board Pro BC-Type <i>Panel Sizing Saw Blade</i>	31
Board Pro Scoring <i>Scoring Saw Blade</i>	33
Eco Saw Blade <i>Hollow Face Panel Sizing Saw Blade</i>	39
Board Pro Plus <i>Finish Cut For Table Saw Blade</i>	41
Table Saw Blade <i>Finish Cut Saw Blade</i>	43
DIA V-tech <i>Finish Cut Panel Sizing Saw Blade</i>	45
Board Pro DIA <i>Heavy Duty Panel Sizing Saw Blade</i>	47

Non-ferrous Metals

Sash Pro <i>Heavy Duty Saw Blade</i>	51
Stable Saw Blade <i>Thin Kerf Saw Blade</i>	53

Timber Max

Heavy Duty Rip Saw Blade

APPLICATION

Heavy duty rip sawing and re-sawing

MACHINE

Heavy sawmill equipment such as Linck, HewSaw, EWD, Soederhamm

Gang rip saws such as Paul, Raimann

MATERIAL

Softwoods, hardwoods (green and dry)

EDGE MATERIAL

HW



► Features & Benefits

- Stable and flat plate enables truer run-out for smoother finish and exact dimensions
- No or only little plate distortion after use reduces time for straightening after sharpening
- Durable and corrosion resistant carbide tips enable longer edge life
- Saw blades show excellent performance even under heaviest conditions such as active curve sawing

Available with wipers located in various positions according to the application

In example

Z = 24+2 = 24 teeth, 2 wipers outside

Z = 24+3 = 24 teeth, 3 wipers outside

Z = 24+2+2 = 24 teeth, 2 wipers outside, 2 wipers inside

Z = 24+0+2 = 24 teeth, 0 wipers outside, 2 wipers inside

Z = 24+2+2+2 = 24 teeth, 2 wipers outside, 2 wipers inside, 2 more wipers inside

Commonly the saw blades are designed and manufactured according to your application

EDGE MATERIAL

HW

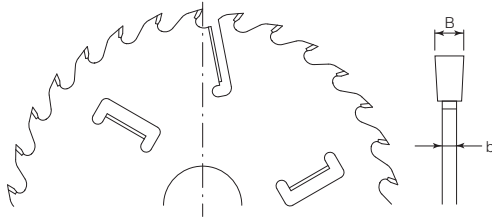
B-Type

Order no.	Size				z	C	Type	Key ways / Pin holes
	D [mm]	B [mm]	b [mm]	d [mm]				
1 684-C580-401	350	3.2	2.2	100	24+3+3	-	D	2x12.5x4
2 684-C581-401	350	4.2	3.0	90	24+3	6	B	2/13/114
3 684-C582-401	350	4.4	3.2	90	24+3	6	B	2/13/114
4 684-C583-401	351	3.6	2.4	70	24+2	4	B	1/6.5/90
5 684-C584-401	351	3.6	2.4	70	30+2+2	-	B	1/6.5/90
6 684-C585-401	351	3.6	2.4	70	30+2+2	4	B	1/6.5/90
7 684-C587-401	351	4.0	2.8	70	30+2+2	-	B	1/6.5/90
8 684-C588-401	450	4.4	3.0	100	30+3+3	-	B	2x25.5x4
9 684-C589-401	450	4.4	3.2	99	30+3+3	-	B	-
10 684-C590-401	450	4.5	3.0	93	28+2	-	B	Spline Arbor
11 684-C591-401	485	4.6	3.2	144.5	24+3	-	B	Spline Arbor
12 684-C592-401	490	4.4	3.0	150	36+3+3	-	B	4x37x9
13 684-C593-401	505	4.6	3.2	150	36+3+3	-	D	4x37x9
14 684-C594-401	505	4.7	3.2	150	30+3+3	-	B	4x37x9
15 684-C595-401	510	4.4	3.0	150	36+3+3	-	B	4x37x9
16 684-C596-401	540	4.2	2.8	210	30+3+3	-	B	2x20x5+12/12/240
17 684-C597-401	540	4.8	3.4	145	30+2+2	-	B	2x20x5+8/12/165
18 684-C598-401	540	4.8	3.4	150	24+3	-	B	2x36.5x9
19 684-C599-401	540	4.8	3.4	150	30+3+3	-	B	2x36.5x9
20 684-C600-401	540	4.8	3.6	210	30+3+3	-	B	2x20x5+12/12/240
21 684-C601-401	560	5.0	3.8	160	24+3+3	-	B	2x23x6+6/12/182.5
22 684-C602-401	565	3.9	2.5	160	42+3+3	-	B	2x22.5x5.5+6/11.5/182.5 + 6/11.5/288

C = Cooling slots

► B-Type

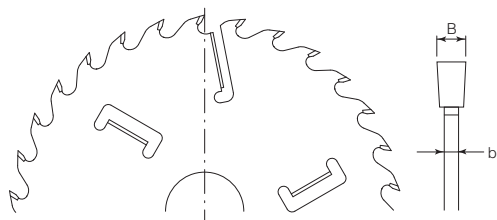

Order no.	D [mm]	B [mm]	Size b [mm]	d [mm]	z	Type	Key ways / Pin holes	Machine
23	200	3.2	2.2	100	48	B	2x12.5x4	Paul
24	200	3.2	2.2	75	48	B	2x16.5x5.5	Paul
25	210	3.2	2.2	60	24	B	2x14.5x5.5	Paul
26	250	2.8	1.8	80	24	B	2x18.5x3.5 +2/13/100	Raimann
27	250	2.8	1.8	70	24	B	2x20x5	
28	250	3.2	2.2	60	20	B	2x14.5x5.5	Paul
29	250	3.2	2.2	70	20	B	2x20x5	
30	250	3.2	2.2	75	24	B	2x16.5x5.5	Paul
31	250	3.2	2.2	75	24	B	2x16.5x5.5	Paul
32	250	3.2	2.2	80	20	B	2x18.5x3.5 +2/13/100	Raimann
33	300	2.8	1.8	80	24	B	2x18.5x3.5 +2/13/100	Raimann
34	300	3.2	2.2	80	24	B	2x18.5x3.5 +2/13/100	Raimann
35	300	3.2	2.2	70	20	B	2x16.5x5.5	Paul
36	300	3.2	2.2	70	24	B	2x16.5x5.5	Paul
37	300	3.2	2.2	70	28+2+2	B	2x20x5	
38	300	4.2	2.6	75	24	B	2x16.5x5.5	Paul
39	315	3.2	2.2	80	28+2	B	2x12.5x4.5	
40	350	3.5	2.5	80	28	B	2x18.5x3.5 +2/13/100	Raimann
41	350	3.5	2.5	70	28	B	2x20x5	
42	350	3.5	2.5	70	20+2+2	B	2x20x5	
43	350	3.8	2.5	80	20+2+2	B	2x18.5x3.5 +2/13/100	Raimann
44	350	3.8	2.5	70	20+2+2	B	2x20x5	
45	350	4.8	3.0	75	24+3	B	2x16.5x5.5	Paul
46	380	5.2	3.2	75	24+3	B	2x16.5x5.5	Paul
47	460	5.4	3.6	75	24+3	B	2x16.5x5.5	Paul

EDGE MATERIAL
HW

► B-Type

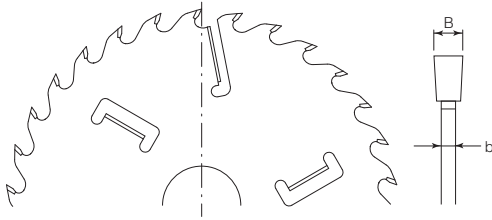

Order no.	D [mm]	B [mm]	Size b [mm]	d [mm]	z	Type	Key ways / Pin holes	Machine
48	500	5.8	4.0	130	24	B	2x16.5x8.5	Paul
49	550	6.0	4.0	110	24+3	B	2x16.5x8.5	Paul
50	550	6.0	4.0	130	24+3	B	2x16.5x8.5	Paul
51	600	5.8	4.0	110	20+2	B	2x16.5x8.5	Paul
52	620	5.6	4.2	130	20+2	B	2x16.5x8.5	Paul

Timber Max TK

Thin Kerf Splitting Saw Blade

APPLICATION

Cutting solid timber into thin slats used in the production of parquet flooring, blinds, etc.

MACHINE

Splitting machines such as Weinig, Schroeder, Leadermac

MATERIAL

Softwoods, hardwoods

EDGE MATERIAL

HW

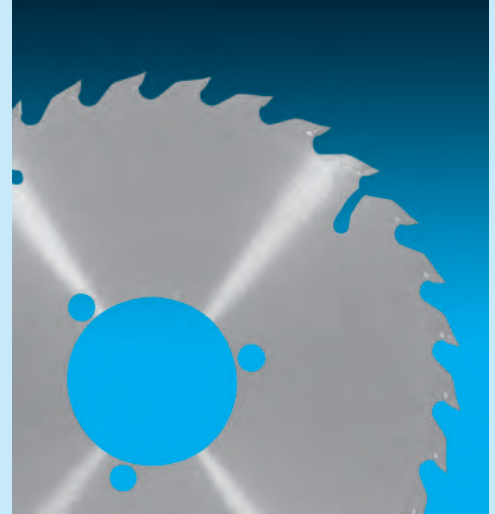

► Features & Benefits

- Thin kerf enables a tremendous increase in yield rates
- No or small step at the overlapping area between 2 saw blades due to tight manufacturing tolerances and a very flat and even plate
- All saw blades are custom made according to the application



Lubrication System

We have developed a saw plate lubrication system, which reduces the friction between the saw blade and the material by releasing a very small amount of lubricant from the sleeve directly onto the plate. Centrifugal force distributes the lubricant evenly over the plate

- Less saw blades bend, crack or dish by frictional heating
- Enables higher feed speed
- Provides higher process reliability

For more information, please contact Kanefusa

EDGE MATERIAL
HW

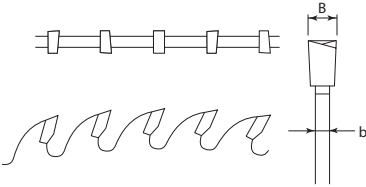
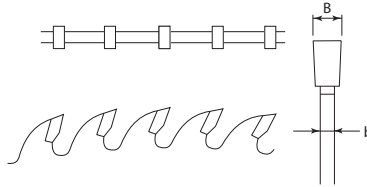
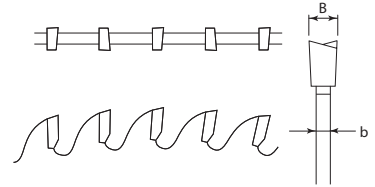
A-Type

B-Type

BC-Type

Order no.	D [mm]	B [mm]	Size		z	Type	Pin holes	
			b [mm]	d [mm]				
1	180	1.1	0.8	60,65,70	30	A,B,BC	3/10/75,3/11/80	For Scoring
2	200	1.2	0.8	60,65,70	30	A,B,BC	3/10/75,3/11/80	
3	200	1.4	1.0	60,65,70	30	A,B,BC	3/10/75,3/11/80	
4	220	1.2	0.8	60,65,70	30	A,B,BC	3/10/75,3/11/80	
5	220	1.4	1.0	60,65,70	30	A,B,BC	3/10/75,3/11/80	
6	250	1.4	1.0	60,65,70	30	A,B,BC	3/10/75,3/11/80	
7	250	1.7	1.2	60,65,70	30	A,B,BC	3/10/75,3/11/80	
8	250	1.8	1.2	60,65,70	30	A,B,BC	3/10/75,3/11/80	
9	280	1.8	1.2	60,65,70	30	A,B,BC	3/10/75,3/11/80	
10	280	2.0	1.4	60,65,70	30	A,B,BC	3/10/75,3/11/80	

Tough Black

Saw Body Coating

APPLICATION

Special coating on the saw blade body to reduce friction between the saw blade body and solid wood

MATERIAL

Softwoods, hardwoods



► Features & Benefits

- Reduces friction between the body and the material
- Enables a longer tool life for more machine uptime
- Depending on the application, the saw kerf can be reduced or the feed speed increased
- Tough Black is optional for our rip saw blades up to diameter 770 mm
- Not for use in panel processing



SF-Saw Blade

Glueline Saw Blade

APPLICATION

Ripping solid wood in glueline (super finish) quality

MACHINE

Gang rip saw, moulder, table saw

MATERIAL

Softwoods, hardwoods

EDGE MATERIAL

HC-UP

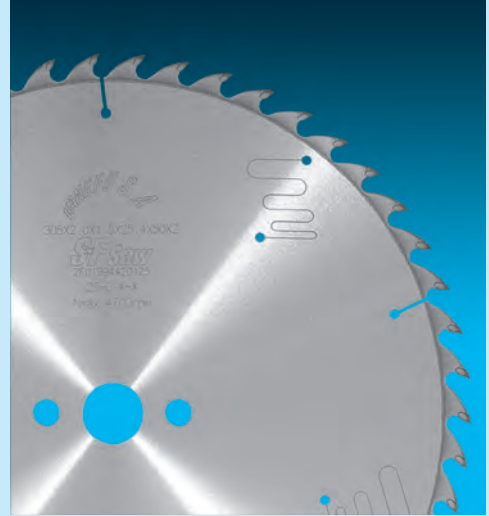

※HC-UP coating requires a special resharpening method
PAT.EP0739697, EP1048385, EP1155792, US6708594

Features & Benefits

- Special tooth shape enables a nearly knife mark free cut finish
- Subsequent sanding or planing can be reduced or eliminated
- Advanced Material Technology reduces residue adhesion enables running consistently high feed rates
- Has proven effect at feed rates of more than 200 m/min on moulders

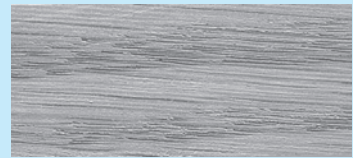
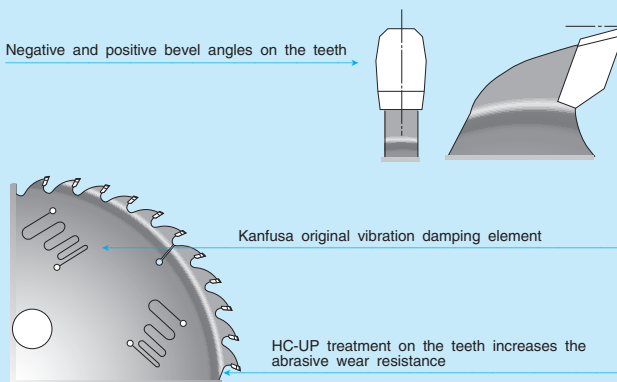

SF – Saw Blade

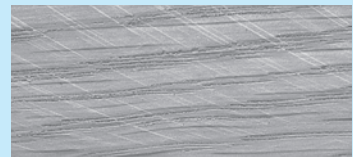

Conventional – Saw Blade

EDGE MATERIAL

HC-UP

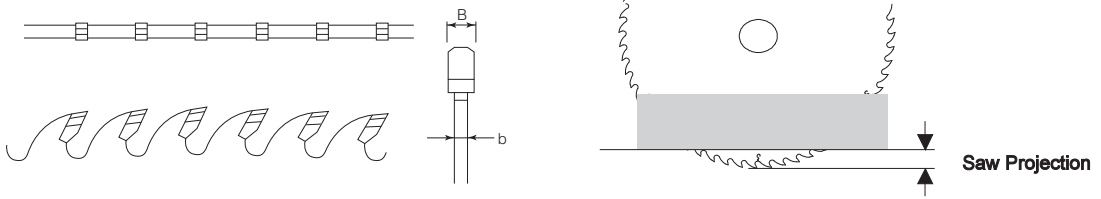
Z-Type

Order no.	D [mm]	B [mm]	Size b [mm]	d [mm]	z	Type	Pin holes	Saw P. [mm]	Material thickness [mm]
1	250	2.8	1.8	30-80	50	Z		5	<30
2	250	2.8	1.8	30-80	40	Z		5	<40
3	300	2.8	1.8	30-80	50	Z		5	<40
4	300	2.8	2.0	30-80	40	Z		5	<70
5	320	3.0	2.0	30-80	50	Z		5	<40
6	320	3.0	2.0	30-80	40	Z		5	<60
7	320	3.0	2.0	30-80	36	Z		5	<80
8	350	3.0	2.0	30-80	50	Z		5	<50
9	350	3.0	2.0	30-80	40	Z		5	<70
10	350	3.4	2.4	30-80	36	Z		5	<90
11	360	3.0	2.0	30-80	50	Z		5	<50
12	360	3.0	2.0	30-80	40	Z		5	<70
13	360	3.4	2.4	30-80	36	Z		5	<100
14	380	3.6	2.6	30-80	50	Z		5	<50
15	380	3.6	2.6	30-80	40	Z		5	<80
16	380	3.6	2.6	30-80	36	Z		5	<110
17	400	3.8	2.8	30-80	50	Z		5	<50
18	400	3.8	2.8	30-80	40	Z		5	<80
19	400	3.8	2.8	30-80	36	Z		5	<110
20	420	3.8	2.8	30-80	50	Z		5	<50
21	420	3.8	2.8	30-80	40	Z		5	<80
22	420	3.8	2.8	30-80	36	Z		5	<110
23	644-A147-470	250	2.8	2.0	30	40	Z	2/10/60	
24	644-A148-470	300	3.0	2.0	30	50	Z	2/10/60	
25	644-A154-470	350	3.2	2.2	30	60	Z	2/10/60	
26	644-A106-470	225	3.0	2.0	59.96	24	Z	3/9/74	

Yield Pro

Fine Cross Cut Saw Blade

APPLICATION

Cross cutting of solid wood

MACHINE

Optimizing saws, cut-off saws

MATERIAL

Softwoods, hardwoods, MDF, HDF with and without lamination

EDGE MATERIAL

HW

PAT.CA2542470, CN ZL200480030284, EP1679165, ID P0024180,
IN234055, KR10-1041312, RU2348513, US8042443, TWI316882

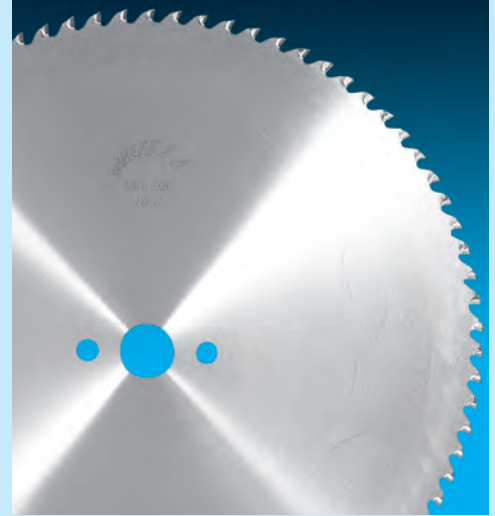

► Features & Benefits

- Thin kerf enables a tremendous increase in yield rates
- Less swarf produced
- Runs consistently on cycle times of less than 0.2 sec.
- Thin kerf makes less cutting pressure for very clean cut

Yield Pro

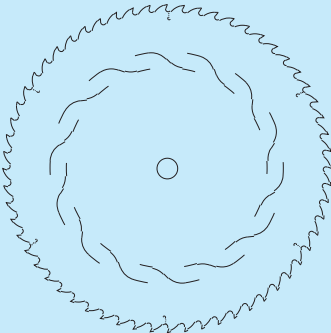

Patented laser slit design allows reducing the plate thickness without compromising the saw blade's lateral stiffness.

EDGE MATERIAL

HW

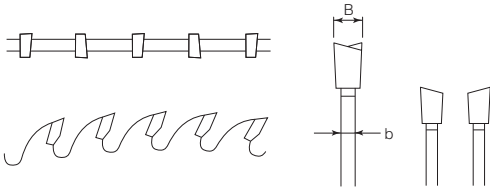
BC-Type

Order no.	D [mm]	B [mm]	Size b [mm]	d [mm]	z	Type	Pin holes	Machine
1	300	2.6	1.6		84	BC		
2	350	2.8	1.8		96	BC		
3	400	3.0	2.0		114	BC		
4	400	3.0	2.0	30	114	BC		Dimter
5	450	3.2	2.2		132	BC		
6	450	3.2	2.2	30	132	BC		Dimter
7	500	3.4	2.4		144	BC		
8	500	3.4	2.4	30	144	BC	2/10/60	Dimter
9	480	3.4	2.4	70	132	BC	6/8/220	Paul 11MKL
10 659-D461-402	500	3.4	2.4	70	132	BC	6/8/220	Paul 11MKL
11	550	4.0	2.8		156	BC		
12	550	4.0	2.8	30	156	BC		Dimter
13	600	4.2	3.0		174	BC		
14	600	4.2	3.0	30	174	BC		Dimter
15 659-C936-401	600	4.2	3.2	120	156	BC	6/10.5/240	Paul C14 MKL
16	600	4.2	3.2	70	156	BC	1/8/140	Paul PushCut CX
17 659-D268-401	620	4.5	3.5	120	156	BC		Paul
18 659-D378-401	700	4.8	3.8	120	132	BC	6/10.5/240	Paul
19 659-D379-401	700	4.8	3.8	120	180	BC	6/10.5/240	Paul

Board Pro III

Heavy Duty Panel Sizing Saw Blade

APPLICATION

Sizing of panel material in single sheets and stacks

MACHINE

Beam saw

MATERIAL

Core : Particleboard, MDF, HDF
Lamination : Melamine, HPL, paper, foil

EDGE MATERIAL

HW



Features & Benefits

- Special carbide grade outlasts conventional grades 2-3 times enabling more machine run time
- Saw blade runs quieter due to vibration damping slits in the plate
- Extreme flat plate and tight manufacturing tolerances enable a truer run out for a better cut quality

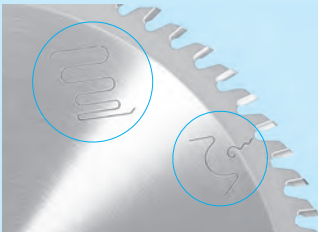

Kanefusa original developed polymer injected laser slits dampen vibration of the saw body. Therefore our saw blades run quieter and micro abrasion of the carbide due to vibration is suppressed.

Damping Effect of MS-P

- Normal Slit
- ◆ MS-P Slit

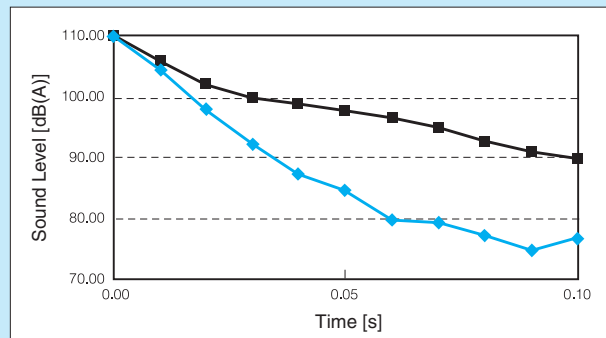

▶ D-Type

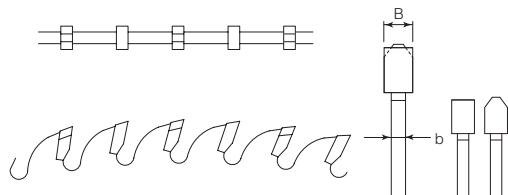

Order no.	D [mm]	B [mm]	Size b [mm]	d [mm]	z	Type	Pin holes	Machine
1 691-E259-403	300	4.4	3.0	30	60	D	2/10/60	Panhans Euro 10
2 691-E260-403	300	4.4	3.0	75	72	D		Homag CH03
3 691-A149-403	303	3.0	2.2	30	48	D	2/10/60+2/7/42	Striebig
4 691-A321-403	303	3.0	2.2	30	60	D	2/10/60+2/9/44	Striebig
5 691-B086-403	303	3.0	2.2	30	100	D	2/10/60+2/9/44	Striebig
6 691-D936-403	303	3.2	2.2	30	100	D	2/10/60+2/9/44	Striebig
7 691-A356-403	305	3.2	2.2	30	60	D	2/10/80	Scheer FM16
8 691-D938-403	305	4.4	3.0	30	60	D		Mayer ; Panhans
9 691-E387-403	305	4.4	3.2	60	60	D		
10 691-E261-403	305	4.0	2.8	30	54	D		Mayer
11 691-A628-403	305	4.4	3.0	30	60	D	2/10/60	
12 691-E263-403	320	4.4	3.2	75	72	D	3/13/95	Giben Smart 65
13 691-A153-403	350	3.2	2.2	30	80	D	2/10/60	
14 691-D941-403	350	3.2	2.0	30	108	D		
15 691-E264-403	350	4.4	3.0	30	54	D	2/10/60	SCM ; Panhans EURO12 ; Mayer ; Schelling
16 691-D942-403	350	4.4	3.2	30	72	D	2/10/60	SCM ; Panhans EURO12 ; Mayer ; Schelling
17 691-B857-403	350	4.4	3.0	80	72	D	2/14/110+ 4/9/100	Gabbiani Prima ; SCM Alpha ; Scheer FM21
18 691-D294-403	350	4.4	3.2	30	54	D	2/12/80	SCM
19 691-B583-403	350	4.4	3.2	75	72	D	2/10/120	Giben
20 691-E265-403	355	4.0	3.0	30	54	D		
21 691-A469-403	355	4.4	3.0	80	72	D	2/10/130	SMA ; Zerspaner
22 691-B072-403	355	4.4	3.2	75	60	D		Giben
23 691-D142-403	355	4.4	3.2	75	72	D	4/15/105	Giben
24 691-E267-403	355	4.4	3.2	30	72	D	2/10/60	Panhans
25 691-E268-403	355	4.4	3.2	80	72	D	4/9/100+4/14/110	Gabbiani

► D-Type

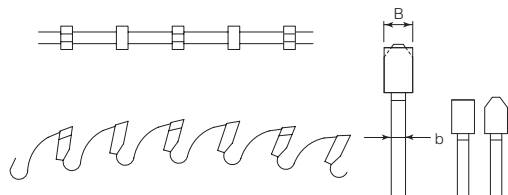

Order no.	D [mm]	B [mm]	Size b [mm]	d [mm]	z	Type	Pin holes	Machine
26 691-D389-403	360	4.4	3.2	65	72	D	2/9/110	Selco EB100
27 691-E270-403	370	4.4	3.2	30	72	D		Schelling FM/H
28 691-E271-403	380	4.4	3.2	60	72	D	2/14/100	
29 691-D948-403	380	4.8	3.5	60	72	D	2/14/100	Holzma
30 691-C017-403	400	3.5	2.4	30	72	D	2/10/60	
31 691-A475-403	400	4.25	3.2	30	72	D	2/10/60	Scheer
32 691-D831-403	400	4.4	3.2	30	72	D	2/10/60	Panhans, Schelling, Scheer
33 691-D952-403	400	4.4	3.0	60	72	D	2/14/110	Anthon
34 691-D955-403	400	4.4	3.2	80	72	D	2/7/110+ 2/8.3/130	
35 691-B746-403	400	4.4	3.2	80	72	D	2/14/110+4/9/ 110	
36 691-B914-403	400	4.4	3.2	80	72	D	2/9/130+ 4/19/120	Selco WN/EB
37 691-D958-403	400	4.8	3.5	60	72	D		Holzma Type01
38 691-A181-403	420	4.8	3.5	60	72	D		Holzma
39 691-E273-403	420	4.8	3.5	60	84	D	3/14/76	Holzma
40 691-D960-403	430	4.4	3.2	30	72	D		
41 691-D961-403	430	4.4	3.2	60	72	D	2/11/85	Anthon
42 691-C499-403	430	4.4	3.2	75	72	D	4/15/105	
43 691-B734-403	430	4.4	3.2	75	96	D	4/15/105	Giben Prismatic2
44 691-E550-403	430	4.4	3.2	80	72	D	4/19/120+ 2/9/130	Selco WN
45 691-C024-403	450	4.4	3.2	30	72	D	2/10/60+ 2/13/94	Schelling, Scheer FM22
46 691-D968-403	450	4.8	3.5	60	72	D	2/14/125	Holzma
47 691-D969-403	450	4.8	3.5	80	72	D	4/19/120+2/ 9/130+2/14/110	Selco WN



Board Pro III

TD-Type

Finish Cut Panel Sizing Saw Blade

APPLICATION

Sizing of panel material in single sheets and stacks

MACHINE

Beam saw

MATERIAL

Core : Particleboard, MDF, HDF

Lamination : Melamine, HPL

EDGE MATERIAL

HW



Features & Benefits

- TD - type tooth shape enables finish cut quality
- Saw blade runs quieter due to vibration damping slits in the plate
- Extreme flat plate and tight manufacturing tolerances enable a truer run out for a cleaner cut surface

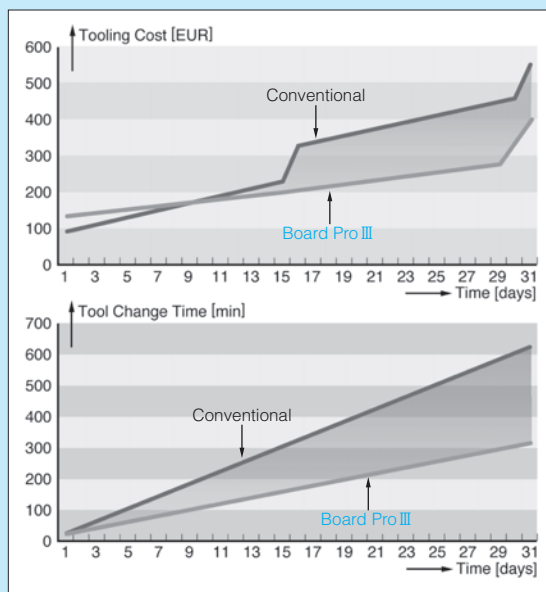

At various major furniture manufacturers from Ukraine to Germany, Turkey to England, Board Pro saw blades clearly outlast saw blades of other quality brands.

The graphs demonstrate what that means to the tooling cost and machine uptime.

The figures are based on experience at a large furniture part manufacturer in Southern Germany.

- Machine : Holzma Powerline
- Feed rate : 28 m/min
- Material : Melamine laminated particleboard 40mm thick
- Saw blade : Board Pro 450 x 4.8 x 3.5 x 60 x 72z TD
- Edge life : Conventional saw blade = 1 day
Board Pro III saw blade = 2 - 3 days

EDGE MATERIAL

HW

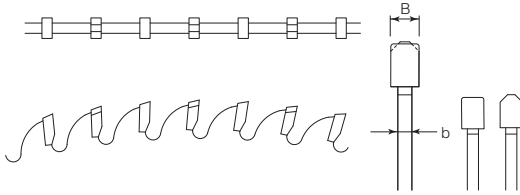
TD-Type

Order no.	D [mm]	B [mm]	Size b [mm]	d [mm]	z	Type	Pin holes	Machine
1 699-J802-403	300	4.4	3.0	30	60	TD	2/10/60	Panhans Euro 10
2 699-J803-403	300	4.4	3.0	75	72	TD		Homag CH03
3 699-J804-403	305	4.4	3.0	30	60	TD	2/10/60	
4 699-J976-403	350	4.4	3.2	30	54	TD	2/10/60	SCM ; Panhans EURO12 ; Mayer ; Schelling
5 699-J805-403	355	4.4	3.2	75	72	TD		Giben
6 699-G046-403	380	4.8	3.5	60	72	TD	2/14/100	Holzma
7 699-K211-403	380	4.8	3.5	60	84	TD	2/14/100	Holzma
8 699-J975-403	400	4.3	3.2	30	72	TD		Scheer
9 699-J974-403	400	4.4	3.2	30	72	TD		Schelling ; Mayer ; Irion ; Scheer
10 699-G871-403	400	4.4	3.2	75	72	TD	4/15/105	Giben Prismatic1 ; Giben Starmatic ;
11 699-G801-403	400	4.4	3.2	80	72	TD	2/14/110+4/9/ 110	Gabbiani
12 699-G043-403	420	4.8	3.5	60	72	TD	2/10/80+ 2/14/125	Holzma
13 699-G048-403	450	4.8	3.5	60	72	TD	2/14/125	Holzma
14 699-G873-403	450	4.8	3.5	80	72	TD	2/8.5/130+ 4/19/120	Selco WN

Board Pro

D-Type

Panel Sizing Saw Blade

APPLICATION

Sizing of panel material in single sheets and stacks

MACHINE

Beam saw

MATERIAL

Core : Particleboard, MDF, HDF
Lamination : Melamine, HPL, paper, foil

EDGE MATERIAL

HW



Features & Benefits

- Saw blade runs quieter due to vibration damping slits in the plate
- Extreme flat plate and tight manufacturing tolerances enable a truer run out for a better cut quality

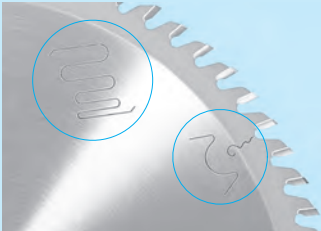

Kanefusa original developed polymer injected laser slits dampen vibration of the saw body. Therefore our saw blades run quieter and micro abrasion of the carbide due to vibration is suppressed.

Damping Effect of MS-P

- Normal Slit
- ◆ MS-P Slit

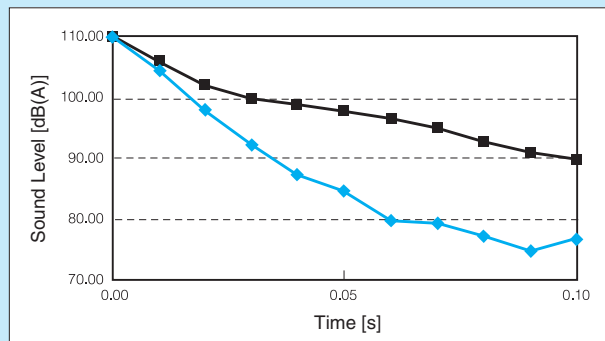

► D-Type

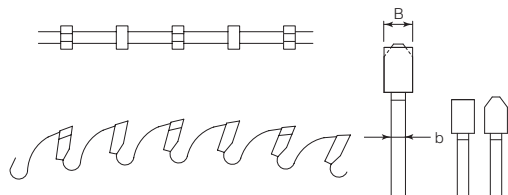

Order no.	D [mm]	B [mm]	Size b [mm]	d [mm]	z	Type	Pin holes	Machine
1 691-B197-403	220	3.2	2.2	30	64	D	2/7/42+ 2/10/60	
2 691-E253-403	230	3.2	2.2	30	64	D	2/7/42+2/9/ 46.5+2/10/60	
3 691-E254-403	240	3.2	2.2	30	54	D	2/6/42	
4 691-B419-403	250	3.2	2.2	30	60	D	2/7.5/42	
5 691-D639-403	250	3.2	2.2	30	80	D	2/7/42+2/9/ 46.5+2/10/60	
6 691-C909-403	280	3.2	2.2	30	60	D	2/7/42+2/9/ 46.5+2/10/60	
7 691-C719-403	300	3.2	2.2	30	72	D	2/7/42+2/9/ 46.5+2/10/60	
8 691-E605-403	300	3.2	2.2	30	96	D	2/7/42+2/9/ 46.5+2/10/60	
9 691-B086-403	303	3.2	2.2	30	100	D	2/7/42+2/9/ 46.5+2/10/60	
10 691-A628-403	305	4.4	3.0	30	60	D	2/10/60	
11 691-A153-403	350	3.2	2.2	30	80	D	2/10/60	
12 691-A660-403	350	3.2	2.2	30	108	D	2/9/44+ 2/10/60	
13 691-B583-403	350	4.4	3.2	75	72	D	2/10/120	Giben
14 691-E258-403	400	3.5	2.4	30	120	D	2/7/42+2/10/60	
15 691-A475-403	400	4.25	3.2	30	72	D	2/10/60	Schelling, Mayer
16 691-A351-403	460	4.6	3.2	30	72	D	2/13/94	
17 691-B951-403	470	4.4	3.2	75	96	D	4/15/105	Giben Prismatic3
18 691-C755-403	480	4.4	3.2	30	80	D		Schelling FL
19 691-D740-403	480	4.8	3.5	80	72	D	4/19/120+2/ 9/130	Selco WN
20 691-D998-403	500	4.4	3.0	75	60	D		Giben
21 691-D999-403	500	4.4	3.2	80	60	D		Teutomatic
22 691-E001-403	500	4.4	3.2	80	72	D		SMA ; Teutomatic
23 691-E002-403	500	4.4	3.2	80	72	D	4/8.5/100+2/14/ 110+2/7/110	Gabbiani A/10
24 691-E003-403	500	4.7	3.4	30	60	D		
25 691-E004-403	500	4.8	3.5	60	60	D	2/11/115	Holzma Type21

► D-Type

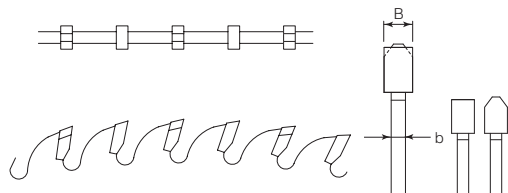

Order no.	D [mm]	B [mm]	Size b [mm]	d [mm]	z	Type	Pin holes	Machine
26 691-A629-403	500	4.8	3.5	60	72	D		Holzma Typ 22
27 691-E006-403	520	4.8	3.5	60	60	D		Holzma
28 691-E007-403	530	5.0	3.5	30	60	D		Schelling
29 691-E008-403	530	5.8	4.0	60	60	D	1/11/85	Anthon
30 691-E009-403	550	5.0	3.5	40	72	D		Schelling
31 691-E010-403	550	5.0	3.5	80	72	D		Teutomatic
32 691-E011-403	550	5.0	3.5	100	72	D		Giben
33 691-E012-403	570	4.8	3.5	60	60	D		Holzma
34 691-E013-403	570	5.8	4.0	60	96	D		Holzma Typ 42
35 691-E014-403	580	5.5	4.0	40	60	D		Schelling
36 691-E015-403	600	5.8	4.0	60	72	D	2/19/120+2/ 11/115	Holzma Typ 42
37 691-E016-403	600	6.2	4.0	80	72	D		SMA
38 691-E017-403	620	6.2	4.0	40	72	D		Schelling FT
39 691-E018-403	650	6.2	4.0	40	72	D		Schelling
40 691-E020-403	670	6.2	4.0	40	72	D		Schelling
41 691-E021-403	680	6.2	4.2	40	60	D		Schelling AS
42 691-C712-403	700	6.2	4.4	80	60	D	2/17/110	Anthon



Board Pro

BC-Type

Panel Sizing Saw Blade

APPLICATION

Sizing of panel material in single sheets and stacks

MACHINE

Beam saw

MATERIAL

Core : Particleboard, MDF, HDF, plywood, OSB

Lamination : Paper, foil, veneer

EDGE MATERIAL

HW



Features & Benefits

- Saw blade runs quieter due to vibration damping slits in the plate
- Extreme flat plate and tight manufacturing tolerances enable a truer run out for a better cut surface

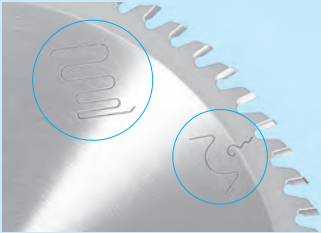

Kanefusa original developed polymer injected laser slits dampen vibration of the saw body. Therefore our saw blades run quieter and micro abrasion of the carbide due to vibration is suppressed.

Damping Effect of MS-P

- Normal Slit
- ◆ MS-P Slit

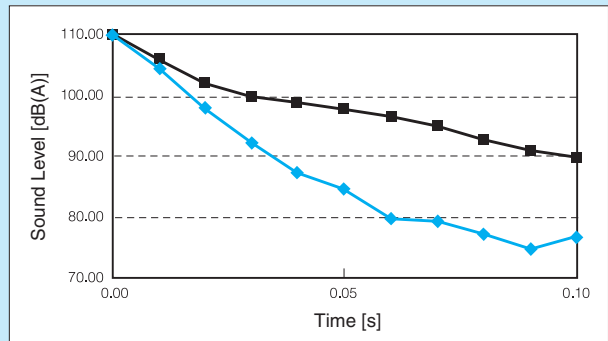

EDGE MATERIAL
HW

▶ **BC-Type**

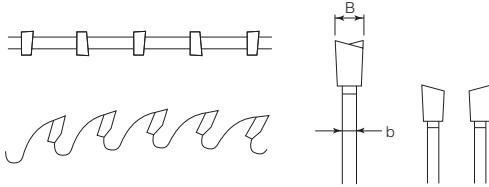

Order no.	D [mm]	B [mm]	Size b [mm]	d [mm]	z	Type	Pin holes
1 659-A719-403	250	3.2	2.2	30	80	BC	2/10/60
2 659-C636-401	300	3.2	2.2	30	72	BC	2/7/42+2/9/ 46.5+2/10/60
3 659-C673-401	300	3.2	2.2	30	96	BC	2/7/42+2/9/ 46.5+2/10/60
4 659-A836-403	300	3.2	2.2	30	60	BC	2/10/60
5 659-A715-403	300	3.2	2.2	30	72	BC	2/10/60
6 659-A720-403	300	3.2	2.2	30	96	BC	2/10/60
7 659-A608-403	350	3.5	2.5	30	54	BC	2/10/60
8 659-A718-403	350	3.2	2.2	30	72	BC	2/10/60
9 659-A712-403	350	3.2	2.2	30	84	BC	2/10/60
10 659-D978-403	355	4.4	3.2	30	54	BC	2/10/60
11 659-D979-403	355	4.4	3.2	30	72	BC	2/10/60

Board Pro Scoring

Scoring Saw Blade

APPLICATION

Scoring of laminated panel material to avoid tear outs on the bottom

MACHINE

Beam saw, vertical panel saw, table saw

MATERIAL

Core : Particleboard, MDF, HDF
Lamination : Melamine, paper, foil

EDGE MATERIAL

HW



Features & Benefits

- Optimum scoring depth is 1.5 mm — 2.5 mm
- Cutting width of CA-type is adjusted with shims

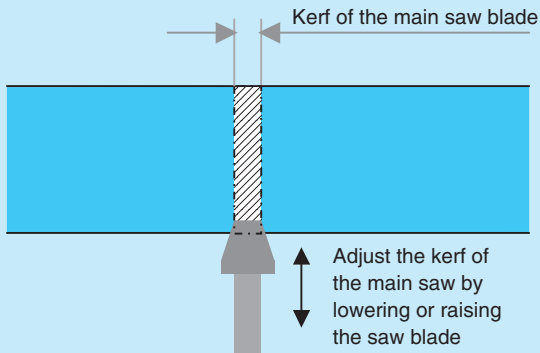

▶ TP-Type

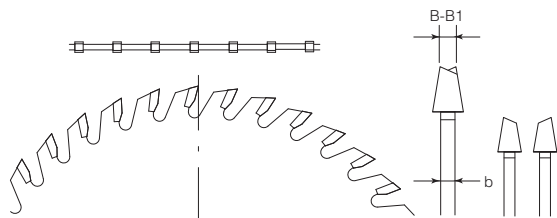

Order no.	Size						Type	Pin holes	Machine
	D [mm]	B [mm]	B1 [mm]	b [mm]	d [mm]	z			
1 699-J807-403	100	3.0	4.0	2.6	20	20	TP		Schelling
2 699-E376-403	100	2.8	3.6	2.0	22	24	TP		
3 699-J808-403	120	3.1	4.3	2.8	20	24	TP		
4 699-J809-403	125	3.1	4.3	2.8	20	24	TP		Panhans 693, Euro 5
5 699-J810-403	125	4.4	5.6	3.4	20	24	TP		Panhans 692, Euro 5
6 699-J811-403	125	3.1	4.3	2.8	22	24	TP		Martin T83, T84
7 699-J812-403	125	4.4	5.6	3.4	45	24	TP		Homag
8 699-E517-403	125	4.4	5.2	3.2	45	20	TP		
9 699-F179-403	125	4.4	5.45	2.8	20	24	TP		Panhans
10 699-J813-403	127	4.4	5.6	3.4	22	24	TP		Martin T83, T84
11 699-J814-403	127	3.8	5.0	2.8	45	24	TP		Giben
12 699-J815-403	127	4.0	5.2	3.4	45	24	TP		Giben, Mayer Lombach
13 699-D175-403	127	4.3	5.6	3.3	45	24	TP		PS 3 + 7 Giben
14 699-J816-403	140	3.1	4.3	2.8	16	32	TP	1/6/33	Scheer FM 9+15
15 699-J817-403	140	4.4	5.6	3.4	45	28	TP		Euromac (Holz Her)
16 699-J818-403	150	3.0	4.0	2.6	30	28	TP		
17 699-J819-403	150	4.0	5.2	3.4	30	28	TP		SCM Z45
18 699-J820-403	150	4.2	5.4	3.4	30	28	TP		Irion + Denz PPA+PPQ
19 699-J821-403	150	4.4	5.6	3.4	30	28	TP		Mayer Lombach PS2
20 699-J822-403	150	4.4	5.6	3.4	45	28	TP		Homag Espana CH06/10
21 699-J823-403	160	3.1	4.0	2.6	20	32	TP		Langzauner
22 699-J824-403	160	4.4	5.6	3.2	30	28	TP		
23 699-J825-403	160	4.4	5.6	3.2	45	28	TP	3/11/70	Giben
24 699-J826-403	160	4.4	5.6	3.4	55	36	TP	3/7/66	Gabbiani
25 699-E560-403	160	4.4	5.45	3.0	45	36	TP	3/11/70	Giben Prismatic

EDGE MATERIAL
HW

▶ TP-Type

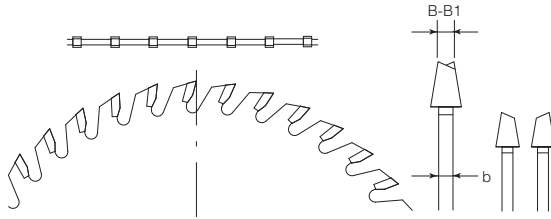

Order no.	Size						Type	Pin holes	Machine
	D [mm]	B [mm]	B1 [mm]	b [mm]	d [mm]	z			
26 699-J827-403	175	4.6	5.8	3.5	45	28	TP		Holzma
27 699-J828-403	180	3.1	4.3	2.8	16	42	TP	1/6/33	Scheer FM 10/11/12
28 699-J829-403	180	4.4	5.6	3.4	20	28	TP		Schelling, Anthon
29 699-J830-403	180	4.4	5.6	3.4	30	28	TP	2/7/42+2/10/60	Panhans 693, Euro 12/32
30 699-G318-403	180	4.8	5.8	3.5	45	36	TP		Holzma
31 699-J151-403	180	4.4	5.6	3.2	45	36	TP		Holzma
32 699-J831-403	180	6.8	7.8	5.0	20	36	TP		Anthon, Schelling
33 699-G319-403	200	4.8	5.8	3.5	45	36	TP		Holzma
34 699-J832-403	200	5.9	6.9	3.5	45	36	TP		Holzma
35 699-J833-403	200	6.2	7.2	4.2	45	36	TP		Holzma Typ 66
36 699-J834-403	200	3.2	4.3	2.8	30	60	TP		Scheer FM 16
37 699-J835-403	200	4.4	5.6	3.2	30	36	TP	2/8.5/60	Scheer FM 14/21/22
38 699-J836-403	200	4.8	5.8	3.5	30	36	TP	2/8.5/60	Scheer FM 22
39 699-J837-403	200	4.0	5.2	3.4	20	24	TP		Schelling
40 699-E989-403	200	4.4	5.6	3.2	20	36	TP		Schelling
41 699-J838-403	200	4.4	5.6	3.4	20	24	TP		Schelling
42 699-A876-403	200	4.6	5.7	3.2	20	34	TP		Schelling
43 699-J839-403	200	5.0	5.8	3.5	20	36	TP		Schelling
44 699-J840-403	200	5.5	6.6	3.8	20	36	TP		Schelling FS, AS
45 699-J841-403	200	6.2	7.2	4.2	20	36	TP		Schelling FS, AS
46 699-J842-403	200	4.4	5.6	3.2	65	36	TP	2/9/110+2/9/100	Selco
47 699-E803-403	200	4.8	5.8	3.2	65	34	TP	2/8.5/110	Selco
48 699-J843-403	200	4.0	5.2	3.4	30	36	TP		Panhans 700
49 699-J844-403	200	4.4	5.6	3.2	50	42	TP	3/13/80	Giben Smart 65
50 699-J845-403	215	4.4	5.6	3.2	50	42	TP	3/15/80	Giben

EDGE MATERIAL
HW

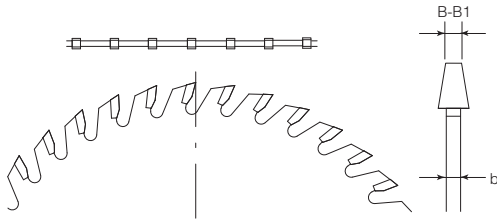
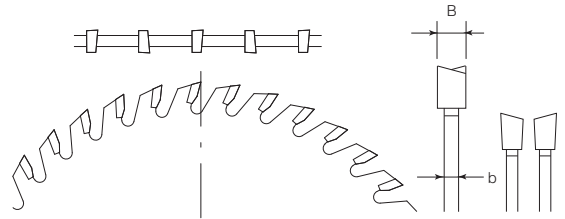
F-Type

BC-Type

Order no.	Size						Type	Pin holes	Machine
	D [mm]	B [mm]	B1 [mm]	b [mm]	d [mm]	z			
51 699-J846-403	300	4.4	5.6	3.5	50	48	TP	3/15/80	Giben

Order no.	Size						Type	Pin holes	Machine
	D [mm]	B [mm]	B1 [mm]	b [mm]	d [mm]	z			
1 699-D888-403	120	3.2	4.5	2.2	22	24	F		
2 699-F521-403	120	3.1	4.22	2.2	20	24	F		
3 699-E214-403	125	3.2	4.3	2.2	22	24	F		Martin
4 699-D960-403	125	4.4	5.45	3.2	45	24	F		Homag
5 699-D782-403	180	4.4	5.6	3.0	30	34	F	2/10/60	
6 699-D557-403	200	4.3	5.5	3.0	20	24	F		Schelling

Order no.	Size					Type	Pin holes	Machine
	D [mm]	B [mm]	b [mm]	d [mm]	z			
1 659-D974-403	280	5.0	3.5	45	84	BC30°		Holzma Typ 82
2 659-D975-403	300	4.6	3.2	65	72	BC10°	2/9/110+2/9/100	Selco
3 659-D976-403	340	5.0	3.5	45	48	BC30°	3/14/65	Holzma
4 659-D977-403	340	5.0	3.5	45	108	BC30°	3/14/65	Holzma

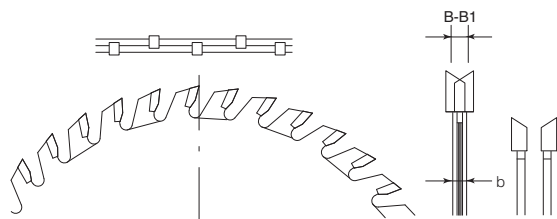
▶ CA-Type



Order no.	Size						Type	Pin holes	Machine
	D [mm]	B [mm]	B1 [mm]	b [mm]	d [mm]	z			
1	80	2.8	3.6	×	20	2x10	CA	Felder	
2	100	2.8	3.6	×	22	2x12	CA	Altendorf Striebig, Score	
3	100	2.8	3.6	×	20	2x12	CA	Panhans 684+685/A MartinT70,Schelling KS	
4	110	2.8	3.6	×	20	2x12	CA	GMC KGS 610S	
5	699-C641-403	120	2.8	3.6	×	22	2x12	CA	Altendorf, Martin T70
6	699-D611-403	120	2.8	3.6	×	20	2x12	CA	Holz Her, SCM S 1
7		120	2.8	3.8	×	22	2x12	CA	2/4.6/39+2/ 4.5/42 Martin T 72 A
8		120	2.8	3.6	×	50	2x12	CA	4/6.2/62 Altendorf
9		120	2.8	3.8	×	50	2x12	CA	4/6.2/62 Altendorf, Griggio, SCM
10		120	4.0	5.0	×	50	2x12	CA	4/6.2/62 Altendorf, Griggio, SCM
11		120	4.0	4.8	×	22	2x12	CA	Martin
12		125	2.8	3.6	×	20	2x12	CA	Paoloni
13		125	2.8	3.6	×	22	2x12	CA	
14		125	2.8	3.8	×	50	2x12	CA	Panhans
15		125	4.0	4.8	×	45	2x12	CA	Giben, Mayer
16		125	4.0	5.0	×	50	2x12	CA	Paolini, Panhans, Kolle
17		160	2.8	3.6	×	30	2x16	CA	Bauerle
18		180	2.8	3.6	×	30	1x18	CA	Kolle
19		180	4.0	4.8	×	20	2x20	CA	Schelling
20		180	4.4	5.6	×	45	2x20	CA	Holzma
21		200	4.0	5.0	×	50	2x28	CA	SCM 450 Postforming



ECO Saw Blade

Hollow Face Panel Sizing Saw Blade

APPLICATION

Sizing of panels in single sheets and stacks in finish cut quality

MACHINE

Vertical panel saw without scoring saw blade

MATERIAL

Core : Particleboard, MDF, HDF
Lamination : Paper, foil, veneer, melamine

EDGE MATERIAL

HW



Features & Benefits

- Special carbide grade outlasts conventional grades 2-3 times
- Saw blade runs quieter due to vibration damping slits in the plate
- DH tooth type for cutting of raw particleboard and MDF as well as paper and veneered panels
- DHC tooth type for cutting plastic laminated particleboard or MDF

Comparison with another quality make

Type A 303 x 3.5 x 2.5 x 30 x 60Z DH
Work Material
Melamine laminated MDF 18 mm thick
Cutting Conditions
N = 4750 rpm F = 10 m/min

Test Result - Evaluation

Lifetime of ECO Saw Blade is about 2.5 times longer than the other make. Cutting noise is lower and cut quality significantly better than the other make.

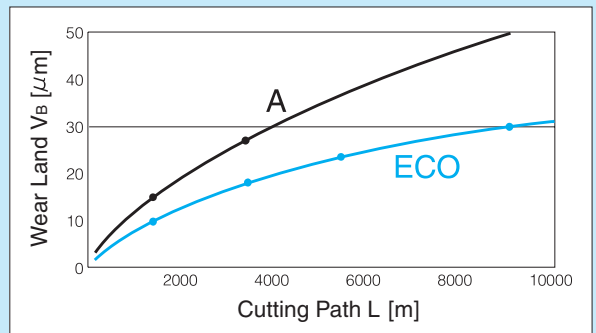

EDGE MATERIAL
HW

▶ DH-Type

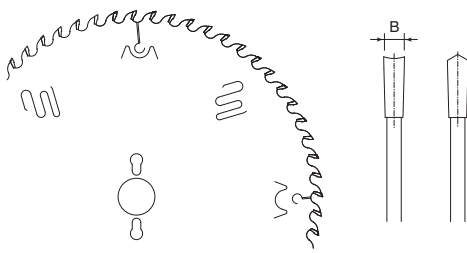

▶ DHC-Type

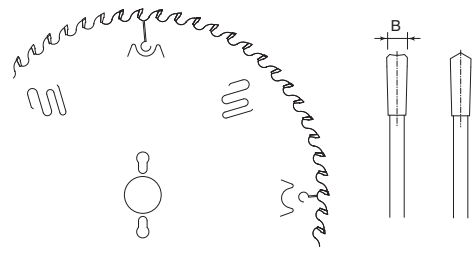

Order no.	D [mm]	B [mm]	Size b [mm]	d [mm]	z	Type	Pin holes	Hook angle [°]
1 645-A083-403	200	2.8	1.8	30	36	DH	2/7/42+2/9/ 46.5+2/10/60	10
2 645-A093-403	220	3.2	2.2	30	42	DH	2/7/42+2/9/ 46.5+2/10/60	10
3 645-A085-403	220	3.2	2.2	30	48	DH	2/7/42+2/9/ 46.5+2/10/60	10
4 645-A078-403	250	3.2	2.2	30	48	DH	2/7/42+2/9/ 46.5+2/10/60	10
5 645-A075-403	303	3.2	2.2	30	60	DH	2/7/42+2/9/ 46.5+2/10/60	10
6 645-A065-403	350	3.2	2.2	30	72	DH	2/7/42+2/9/ 46.5+2/10/60	10
7 645-A086-403	400	3.2	2.2	30	78	DH	2/7/42+2/10/60	10

Order no.	D [mm]	B [mm]	Size b [mm]	d [mm]	z	Type	Pin holes	Hook angle [°]
1 645-A048-403	250	3.2	2.2	30	48	DHC	2/7/42+2/9/ 46.5+2/10/60	10
2 645-A058-403	303	3.2	2.2	30	60	DHC	2/7/42+2/9/ 46.5+2/10/60	10
3 645-A066-403	350	3.2	2.2	30	72	DHC	2/7/42+2/9/ 46.5+2/10/60	10

Order no.	D [mm]	B [mm]	Size b [mm]	d [mm]	z	Type	Pin holes	Hook angle [°]
1 645-A087-403	220	3.2	2.2	30	40	DH	2/7/42+2/9/ 46.5+ 2/10/60	-5
2 645-A088-403	250	3.2	2.2	30	48	DH	2/7/42+2/9/ 46.5+2/10/60	-5
3 645-A075-403	303	3.2	2.2	30	60	DH	2/7/42+2/9/ 46.5+2/10/60	-5
4 645-A090-403	350	3.2	2.2	30	72	DH	2/7/42+2/9/ 46.5+2/10/60	-5
5 645-A091-403	400	3.5	2.4	30	78	DH	2/7/42+2/10/60	-5

Board Pro Plus

Finish Cut For Table Saw Blade

APPLICATION

Sizing of Panel material in finish cut quality

MACHINE

Table saw

MATERIAL

Core : Particleboard, MDF, HDF

Lamination : Melamine, HPL

EDGE MATERIAL

HW

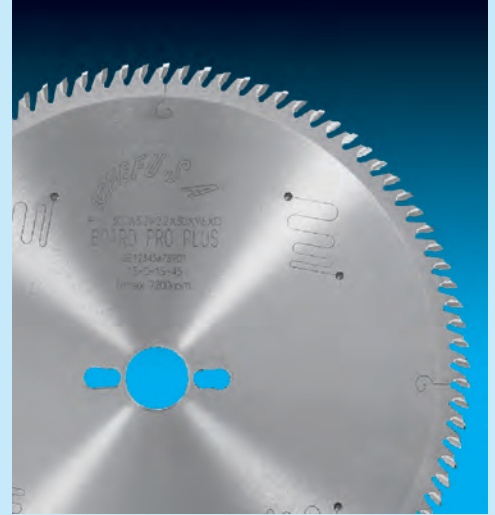

Features & Benefits

- Even and straight saw plate
- Vibration damping slits into the plate
- Tipped with a highly durable Tungsten Carbide grade
- Outlasts conventional saw blades up to 2 times
- Runs very quiet
- Cuts clean and straight

Superior cutting edge finish

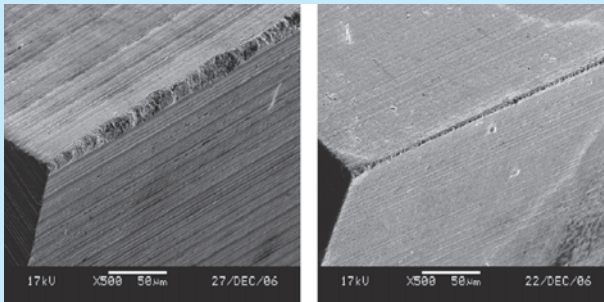

Other make

Kanefusa

EDGE MATERIAL
HW

► **D-Type**

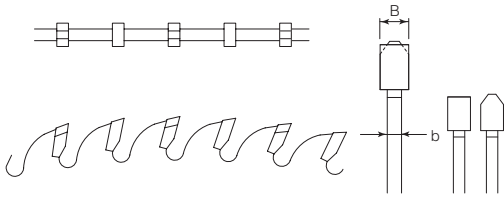

► **BC-Type**

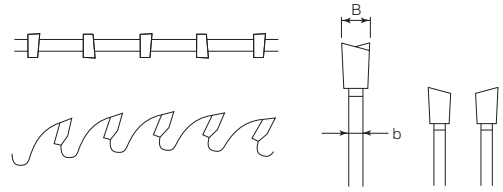

Order no.	D [mm]	B [mm]	Size			z	Type	Pin holes	Machine
			b [mm]	d [mm]					
1 691-E605-403	300	3.2	2.2	30	96	D	2/7/42+2/9/ 46.5+2/10/60		
2 691-F359-403	300	3.2	2.2	25.4	96	D			
3 659-F704-403	250	3.2	2.2	30	80	BC			
4 659-F705-403	300	3.2	2.2	30	96	BC	2/7/42+2/9/ 46.5+2/10/60		

Table Saw Blade

Finish Cut Saw Blade

APPLICATION

Sizing of panel material in single sheets in finish cut quality

MACHINE

Table saw

MATERIAL

Core : Particleboard, MDF, HDF,
Lamination : Paper, foil, veneer, melamine, HPL

EDGE MATERIAL

HW

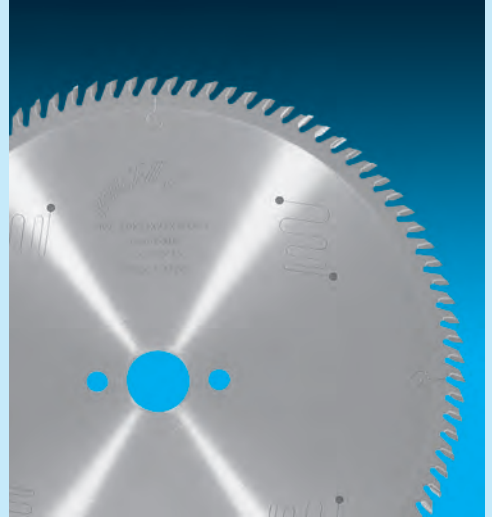

Features & Benefits

- Saw blade runs quieter due to vibration damping slits in the plate
- Extreme flat plate and tight manufacturing tolerances enable a truer run out for a better cut surface quality

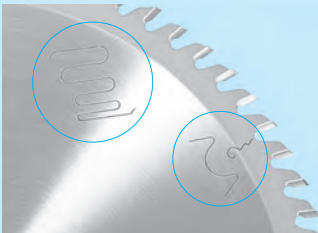

Kanefusa original developed polymer injected laser slits dampen vibration of the saw body. Therefore our saw blades run quieter and micro abrasion of the carbide due to vibration is suppressed.

Damping Effect of MS-P

- Normal Slit
- ◆ MS-P Slit

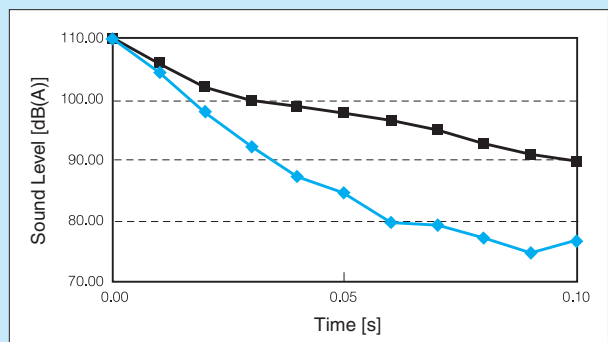

EDGE MATERIAL
HW

► BC-Type

► D-Type

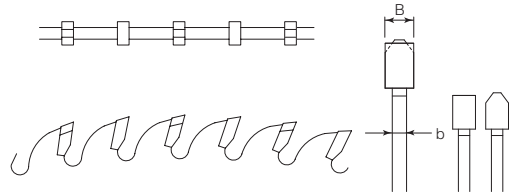
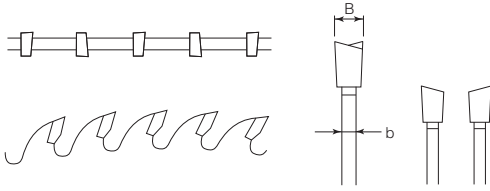

Order no.	D [mm]	B [mm]	Size b [mm]	d [mm]	z	Type	Pin holes
1 659-C636-401	300	3.2	2.2	30	72	BC	2/7/42+2/9/ 46.5+2/10/60
2 659-C673-401	300	3.2	2.2	30	96	BC	2/7/42+2/9/ 46.5+2/10/60
3 691-C719-403	300	3.2	2.2	30	72	D	2/7/42+2/9/ 46.5+2/10/60
4 691-C706-403	300	3.2	2.2	30	96	D	2/7/42+2/9/ 46.5+2/10/60

DIA V-tech

Finish Cut Panel Sizing Saw Blade

APPLICATION

Sizing of panel material in single sheets and stacks in finish cut quality

MACHINE

Vertical panel saw with and without scoring saw blade, beams saws, table saws

MATERIAL

Core : Particleboard, MDF, HDF,
Lamination : Paper, foil, melamine veneer

EDGE MATERIAL

DP



► Features & Benefits

- Cutting forces are well in balance allowing a truer run out and better cut quality
- Because of the aggressive cutting edge, good cut quality on the bottom of the board is obtained

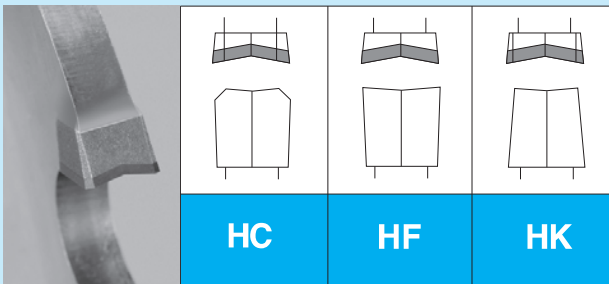

Tooth type HC is suitable to cut melamine laminated board material.

Tooth type HF is suitable to cut paper or veneer laminated board material.

Tooth type HK is for use as a scoring saw blade on beam, panel and table saws.

EDGE MATERIAL
DP

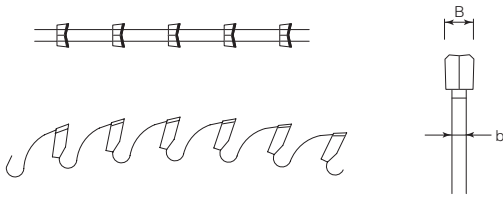
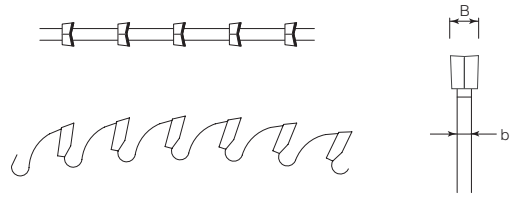
▶ HC-Type

▶ HF-Type

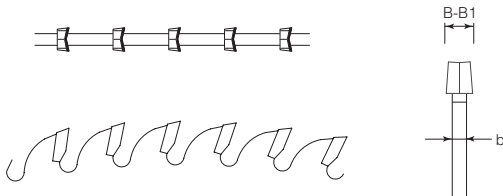
Order no.	D [mm]	B [mm]	Size b [mm]	d [mm]	z	Type	Pin holes
1	303	× 3.2	× 2.2	× 30	× 50	HC	2/7/42+2/10/60
2	303	× 3.2	× 2.2	× 30	× 60	HC	2/7/42+2/10/60
3	303	× 3.2	× 2.2	× 30	× 72	HC	2/7/42+2/10/60
4	380	× 4.4	× 2.2	× 60	× 60	HC	2/14/100
5	450	× 4.8	× 3.5	× 60	× 72	HC	2/11/125
6	303	× 3.2	× 2.2	× 30	× 50	HF	2/7/42+2/10/60
7	303	× 3.2	× 2.2	× 30	× 60	HF	2/7/42+2/10/60
8	303	× 3.2	× 2.2	× 30	× 72	HF	2/7/42+2/10/60
9	380	× 4.4	× 2.2	× 60	× 60	HF	2/14/100
10	450	× 4.8	× 3.5	× 60	× 72	HF	2/11/125

▶ HK-Type

Order no.	D [mm]	B [mm]	Size B1 [mm]	b [mm]	d [mm]	z	Type	Pin holes
11	100	× 3.2	× 4.2	× 2.2	× 22	× 10	HK	
12	120	× 3.2	× 4.2	× 2.2	× 22	× 10	HK	
13	125	× 4.4	× 5.4	× 3.2	× 20	× 10	HK	
14	125	× 4.8	× 5.8	× 3.5	× 45	× 10	HK	
15	160	× 4.4	× 5.4	× 3.2	× 45	× 20	HK	
16	180	× 4.8	× 5.8	× 3.5	× 20	× 24	HK	
17	180	× 4.4	× 5.4	× 3.2	× 30	× 24	HK	
18	200	× 4.8	× 5.8	× 3.5	× 45	× 24	HK	
19	215	× 4.4	× 5.8	× 3.2	× 50	× 24	HK	

Board Pro DIA

Heavy Duty Panel Sizing Saw Blade

APPLICATION

Sizing of panel material in single sheets and stacks

MACHINE

Beams saws, gang rip saws

MATERIAL

Core : Particleboard, MDF, HDF,
 Lamination : Paper, foil, melamine
 Else : Cement-fiber board, various plastics

EDGE MATERIAL

DP



Features & Benefits

- Saw blade runs quieter due to vibration damping elements in the plate
- High quality PCD grades from leading PCD manufacturer enable longer edge life
- Available tooth geometries
 - ▶ J-Type (Inverted V) is suitable for finish and rough cutting of panel materials with hard lamination on both sides, melamine board and various plastics
 - ▶ BC-Type is suitable to cut plywood, raw particleboard and MDF
 - ▶ Other tooth geometries are available upon demand and according to the application

▶ J-Type

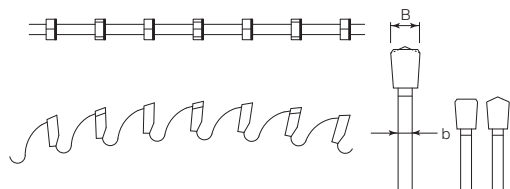

▶ BC-Type

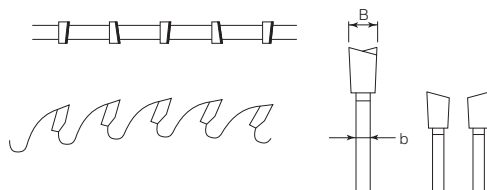

Order no.	D [mm]	B [mm]	Size b [mm]	d [mm]	z	Type	Pin holes	
1	303	3.2	2.2	30	50	J	2/10/60	
2	303	3.2	2.2	30	60	J	2/10/60	
3	303	3.2	2.2	30	72	J	2/10/60	
4	380	4.4	3.2	60	60	J	2/14/100	
5	380	4.4	3.2	60	72	J	2/14/100	
6	400	4.4	3.2	75	60	J	4/15/105	
7	400	4.4	3.2	75	72	J	4/15/105	
8	400	4.8	3.5	30	60	J		
9	400	4.8	3.5	30	72	J		
10	420	4.4	3.2	60	60	J	2/10/80	
11	420	4.4	3.2	60	60	J	2/10/80	
12	430	4.4	3.2	75	60	J	4/15/105	
13	430	4.4	3.2	75	72	J	4/15/105	
14	430	4.4	3.2	60	60	J	2/10/80	
15	430	4.8	3.5	60	72	J	2/10/80	
16	430	4.8	3.5	30	60	J		
17	430	4.8	3.5	30	72	J		
18	450	4.8	3.5	60	60	J	2/14/125	
19	450	4.8	3.5	60	72	J	2/14/125	
20	303	3.2	2.2	30	50	BC	2/10/60	
21	303	3.2	2.2	30	60	BC	2/10/60	
22	303	3.2	2.2	30	72	BC	2/10/60	
23	380	4.4	3.2	60	60	BC	2/14/100	
24	380	4.4	3.2	60	72	BC	2/14/100	
25	400	4.4	3.2	75	60	BC	4/15/105	

► BC-Type

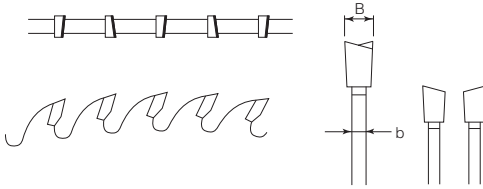

Order no.	D [mm]	B [mm]	Size b [mm]	d [mm]	z	Type	Pin holes
26	400	4.4	3.2	75	72	BC	4/15/105
27	400	4.8	3.5	30	60	BC	
28	400	4.8	3.5	30	72	BC	
29	420	4.4	3.2	60	60	BC	2/10/80
30	420	4.4	3.2	60	60	BC	2/10/80
31	430	4.4	3.2	75	60	BC	4/15/105
32	430	4.4	3.2	75	72	BC	4/15/105
33	430	4.4	3.2	60	60	BC	2/10/80
34	430	4.8	3.5	60	72	BC	2/10/80
35	430	4.8	3.5	30	60	BC	
36	430	4.8	3.5	30	72	BC	
37	450	4.8	3.5	60	60	BC	2/14/125
38	450	4.8	3.5	60	72	BC	2/14/125



Sash Pro

Heavy Duty Saw Blade

APPLICATION

Cutting of extruded profiles, thin sheets and bars

MACHINE

Cut-off machines, beam saws, miter saws

MATERIAL

Non-ferrous metals such as aluminum or brass



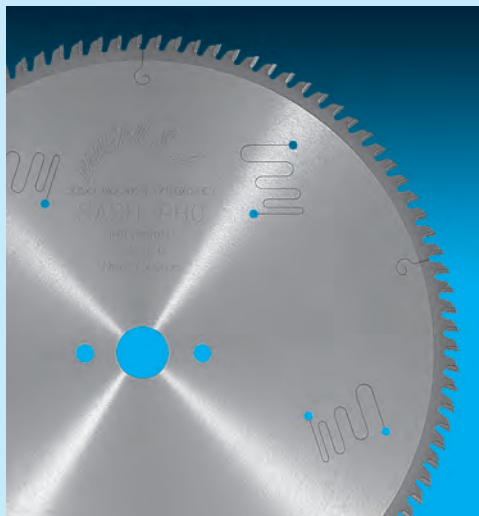

EDGE MATERIAL

HW

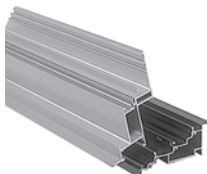

► Features & Benefits

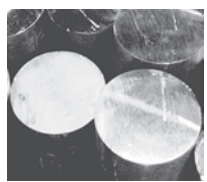
- Runs very quiet due to vibration damping slits LS-P in the plate
- Excellent lifetime and cut quality due to flat and even plate
- Special selected carbide quality guarantees long edge life

Application	Tooth type	Features
Extruded Profiles 	BC5 	<ul style="list-style-type: none"> ■ Less cutting force for lighter cut very light ■ Cuts cleaner than 3DX or D ■ Almost no bending on thin walled material such as lamellas or radiator fins ■ Not recommended for thick walled material (< 4mm) because of vibration
	D 	<ul style="list-style-type: none"> ■ Straight sawing by symmetric tooth geometry ■ Very suitable cutting on thick walled material (> 4mm)
Rods 	D 	<ul style="list-style-type: none"> ■ Straight sawing by symmetric tooth geometry ■ Please ask us about any blade specification such as suitable tooth number for cutting an aluminum solid round bar

EDGE MATERIAL

HW

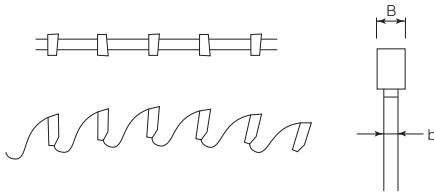
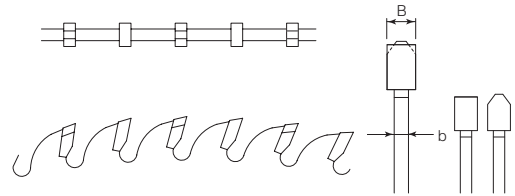
BC5-Type

D-Type

Order no.	D [mm]	B [mm]	Size b [mm]	d [mm]	z	Type	Pin holes	Hook angle [°]
1 681-B480-405	350	3.0	2.4	32	108	BC5	2/14/64	5
2 681-A630-405	400	3.5	3.0	30	120	BC5	2/12/64	5
3 681-B114-405	500	3.5	3.0	30	120	BC5	2/14/64	5
4 681-B482-405	530	4.0	3.4	30	140	BC5	2/14/64	5
5 691-C432-405	215	2.2	1.6	30	60	D		-5
6 691-D207-405	250	3.0	2.4	32	80	D	2/11/63	5
7 691-B207-405	300	3.0	2.4	30	96	D	2/10/60+2/10.5/70	5
8 691-C604-405	300	3.0	2.4	32	96	D	2/11/63	5
9 691-A495-405	300	3.2	2.4	30	72	D	2/10/60	5
10 691-A792-405	300	3.2	2.4	30	96	D	2/12/63	5
11 691-D805-405	350	3.0	2.4	32	108	D	2/11/63	5
12 691-D137-405	350	3.0	2.5	40	84	D	2/11/63	5
13 691-A578-405	350	3.6	2.8	30	108	D	2/10/60	5
14 691-D428-405	352	3.6	2.8	30	108	D	2/10/60	5
15 691-A791-405	400	4.0	3.2	30	96	D	2/12/64	5
16 691-A580-405	420	4.0	3.2	30	100	D		5
17 691-C628-405	430	3.0	2.5	30	60	D		5
18 691-A551-405	450	4.0	3.2	30	108	D	2/12/64	5
19 691-D804-405	450	4.0	3.4	32	140	D		5
20 691-A925-405	500	4.0	3.4	30	120	D	2/10/60+2/13/70+2/12/63	5

Stable Saw Blade

Thin Kerf Saw Blade

APPLICATION

Cutting of extruded profiles and bars

MACHINE

Cut-off machines, beam saws, miter saws,

MATERIAL

Non-ferrous metals such as aluminum or brass

EDGE MATERIAL

HW

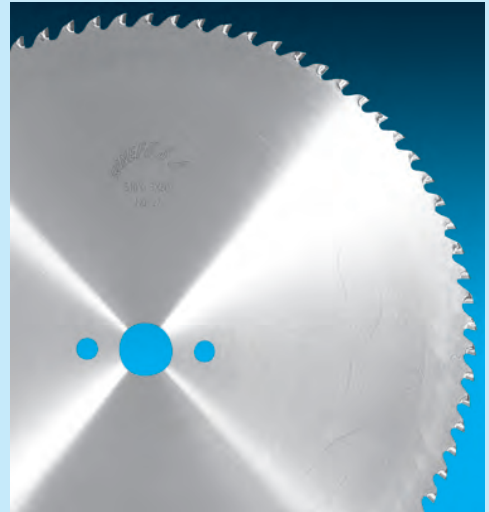

PAT.CA2542470, CN ZL200480030284, EP1679165, ID P0024180,
 IN234055, KR10-1041312, RU2348513, US8042443, TWI316882

Features & Benefits

- Thin kerf improves the material yield rates and reduces the cost for swarf disposal
- Thin kerf reduces the cutting pressure for better cut quality
- On average, Stable Saw Blades are 20% thinner than conventional saw blades

Stable Saw Blade

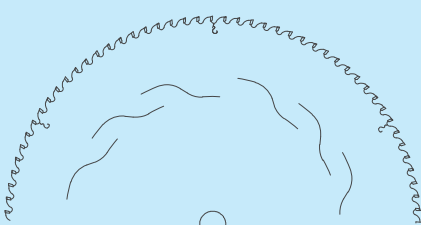

Patented laser slot design allows reducing the plate thickness without compromising the saw blade's lateral stiffness.

Comparison of surface roughness

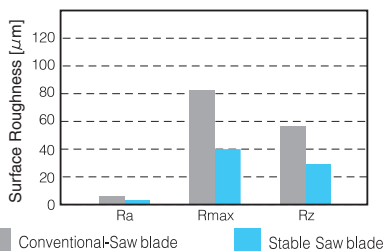

Reduction of cutting noise

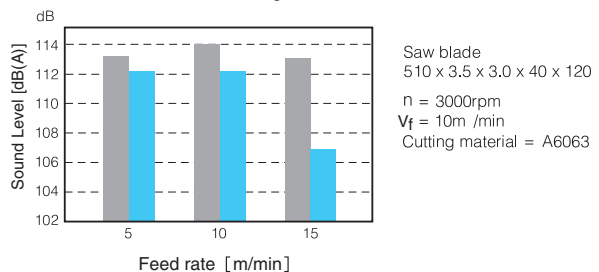

EDGE MATERIAL

HW

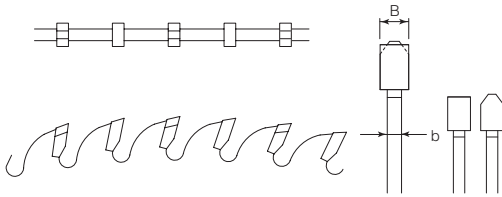
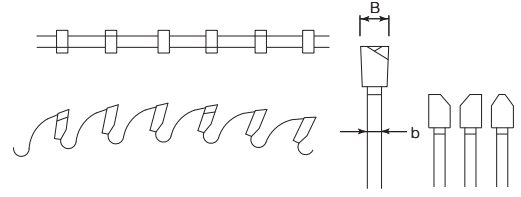
D-Type

3DX-Type

Order no.	D [mm]	B [mm]	Size		z	Type	Pin holes	fl [mm]	RPM [1/min]
			b [mm]	d [mm]					
1	300	× 3.0	× 2.0	×	30	D		93	2700
2	350	× 3.5	× 2.5	×	36	D		108	3200
3	400	× 3.5	× 2.5	×	42	D		124	2800
4	450	× 3.5	× 2.5	×	48	D		140	2500
5	500	× 3.5	× 2.5	×	54	D		155	2250
6	550	× 4.0	× 3.0	×	60	D		170	2000
7	600	× 4.0	× 3.0	×	66	D		186	1850
8	300	× 2.0	× 1.5	×	72	3DX		93	5100
9	350	× 2.5	× 2.0	×	84	3DX		108	4350
10	400	× 2.5	× 2.0	×	96	3DX		124	3800
11	450	× 2.5	× 2.0	×	108	3DX		140	3400
12	500	× 2.5	× 2.0	×	120	3DX		155	3000
13	550	× 3.0	× 2.5	×	132	3DX		170	2800
14	600	× 3.0	× 2.5	×	138	3DX		186	2500

fl=flange diameter

2

Finger Jointing

KANEFU S A

Finger
Jointing

Structural Joints

TAF-Pro *HS-HP tipped Type Finger Joint Cutter* 57

TAF-C *HS-HP Finger Joint Cutter Head* 59

Micro Finger Joint Cutter Head *HS-HP tipped Type Finger Joint Cutter* 61

Millwork Joints

Disc Type Cutter *HC-UP tipped Cutter* 63

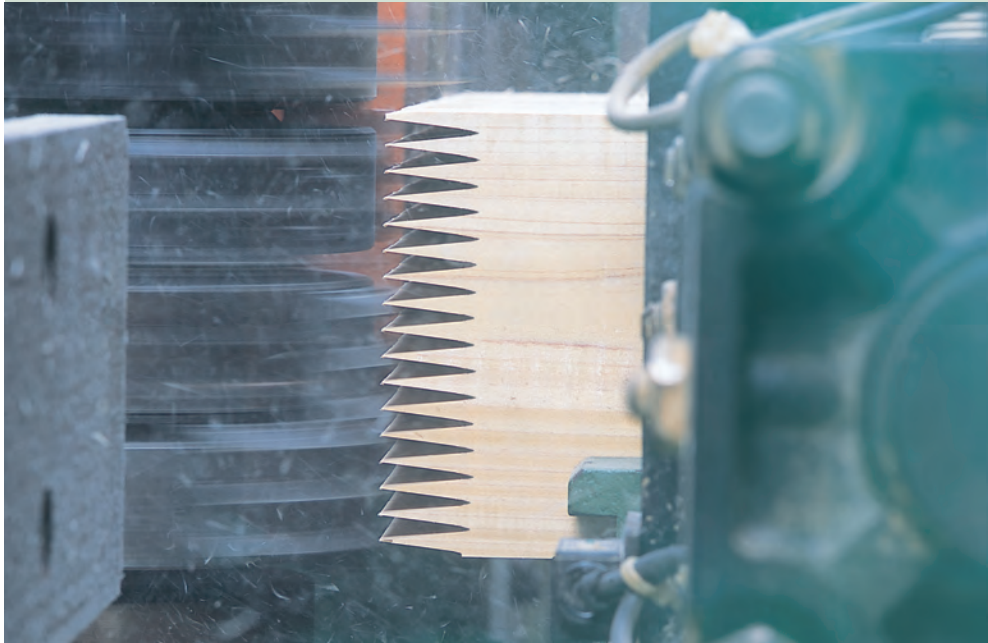

TAF-Pro

HS-HP tipped Type Finger Joint Cutter

APPLICATION

Structural finger joints

MACHINE

Batch feed and through feed machines

MATERIAL

Softwoods

EDGE MATERIAL

HS-HP



※HS-HP coating requires a special resharping method
PAT.EP0739697

Features & Benefits

- Advanced Material Technology cutting edges outlast conventional tooling 3-5 times for longer machine run time and less grinds per month
- Less or no trim saw adjustment guarantees high process reliability
- Cuts cleaner than regular HSS cutters

Maximum timber height [mm] which can be cut according to the number of cutters

Pitch	3.8	6.2
Number of tools	TAF-Pro	TAF-Pro
1	24	28
2	51	59
3	77	90
4	104	121
5	131	152
6	157	183
7	184	214
8	210	245
9	237	276
10	264	307
11	290	338
12	317	

EDGE MATERIAL
HS-HP

► **TAF-Pro Cutters**

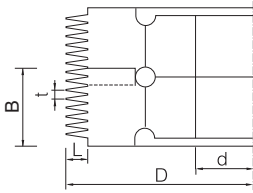

Order no.	Size				Finger joint length L [mm]	Pitch t [mm]	Number of fingers
	D [mm]	B [mm]	d [mm]	z			
1	120	28.6	40	2+2	15/15	3.8	7
2	160	28.6	50	2+2	10/10	3.8	7
3	160	28.6	50	3+3	10/11	3.8	7
4	170	28.6	50	2+2	15/15	3.8	7
5	170	28.6	50	2+2	15/16.5	3.8	7
6	250	28.6	50	3+3	10/11	3.8	7
7	260	28.6	50	3+3	15/16.5	3.8	7
8	180	33.0	50	2+2	20/20	6.2	5
9	260	33.0	50	3+3	20/20	6.2	5
10	260	33.0	50	3+3	20/22	6.2	5
11	170	28.6	50	4+4	15/15	3.8	7
12	170	28.6	50	4+4	15/16.5	3.8	7

TAF-C

HS-HP Finger Joint Cutter Head

APPLICATION

Structural finger joints

MACHINE

Batch feed and through feed machines

MATERIAL

Softwoods

EDGE MATERIAL

HS-HP

※HS-HP coating requires a special resharpener method

PAT.EP0739697, EP1043129, CA2456953, US6644896, US7424900, CNZL 02815463, EP1424176



► Features & Benefits

- Advanced Material Technology cutting edges outlast conventional tooling 3-5 times enabling longer machine run time and less grinds per month
- Less or no trim saw adjustment guarantees high process reliability
- TAF-C knives (block tooth) are built from multi-layered material and outlast conventional tooling

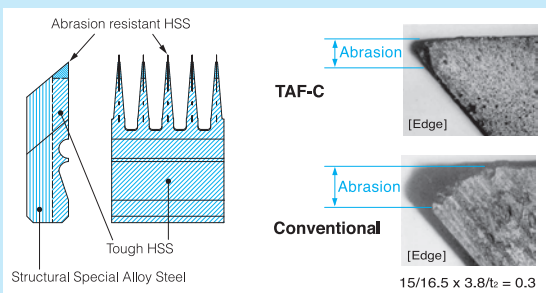

Maximum timber height [mm] which can be cut according to the number of cutters

Pitch	3.8	6.2
Number of tools	TAF-C	TAF-C
1	31	24
2	69	62
3	107	99
4	145	136
5	183	173
6	221	210
7	259	248
8	297	285
9	335	322

The new TAF-C finger joint knives are built from multi-layered steel. The top of the finger is made from highly abrasion resistant High Speed Steel, while the bottom has a higher toughness. This structure is forged on special alloy steel with high shock resistance. The inserts are furthermore treated with Advanced Material Technology. In result, the inserts outlast conventional Advanced Material Technology cutter and are less subject to breakage. Only inserts are available in TAF-C quality.

EDGE MATERIAL
HS-HP

▶ Heads

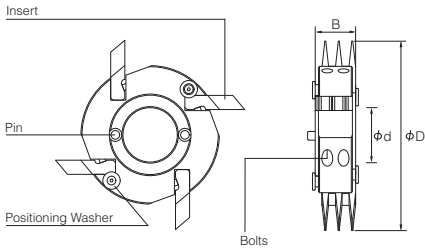

Order no.	Size				Finger joint length L [mm]
	D [mm]	B [mm]	d [mm]	z	
1 887-A105-500	160	38	50	4	10/10
2 887-A020-500	160	38	50	4	10/11
3 887-A072-500	170	38	50	4	15/15
4 887-A036-500	170	38	50	4	15/16.5
5 887-A205-500	180	37.2	50	4	20/20
6 887-A206-500	180	37.2	50	4	20/22
7 887-A004-500	250	38	50	6	10/11
8 887-A207-500	250	38	50	6	10/10
9 887-A022-500	260	38	50	6	15/15
10 887-A021-500	260	38	50	6	15/16.5

▶ Inserts

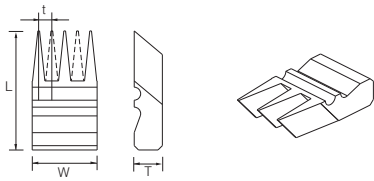

Order no.	Size			Finger joint length L [mm]	Pitch t [mm]	Number of fingers*
	W [mm]	L [mm]	T [mm]			
1 779-0034-611	35	45	13	10/10	3.8	10
2 779-0068-611	35	45	13	10/11	3.8	10
3 779-0042-611	35	50	13	15/15	3.8	10
4 779-1503-611	35	50	13	15/16.5	3.8	10
5 779-0050-611	32.5	55	13	20/20	6.2	6
6 779-0092-611	31	55	13	20/22	6.2	6

*Number of fingers when set in the head

Micro Finger Joint Cutter Head

HS-HP Micro Finger Joint Cutter Head

APPLICATION

Millwork finger joints

MACHINE

Batch feed and through feed machines
*Cutting off saw or hogging unit is indispensable for the Micro Finger

MATERIAL

Softwoods

EDGE MATERIAL

HS-HP



※HS-HP coating requires a special sharpening method
PAT.EP0739697, EP1043129, US6644896

Features & Benefits

- Advanced Material Technology cutting edges outlast conventional tooling 3–5 times enabling longer machine run time and less grinds per month
- Cuts cleaner because of Advanced Material Technology
- Holds about same flexural strength as 11.4mm length standard finger joints with much higher yield and contribution to the environment
- Advanced Material Technology (HS-HP) reduces power consumption and cutting noise for better sustainability and working environment
- Finger block tooth can be reground around 3mm, contributing to edge material saving and reduction of total running cost

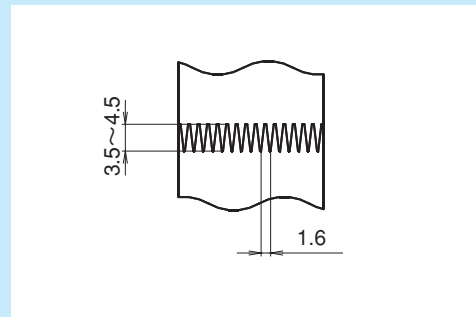
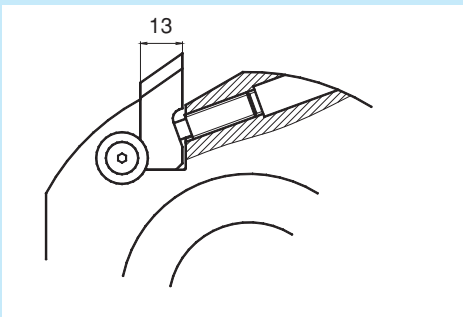

EDGE MATERIAL
HS-HP

► Heads

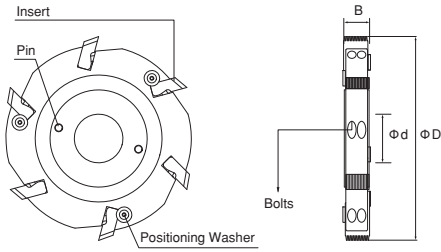

Order no.	Size				Type
	D [mm]	B [mm]	d [mm]	z	
1 887-0000-500	149	25.6	50	4	MZ
2 887-0000-500	160	25.6	50	4	MZ
3 887-0000-500	170	25.6	50	6	MZ
4 887-0000-500	170	25.6	50	6	MZ

*Other specifications are available upon request

► Inserts

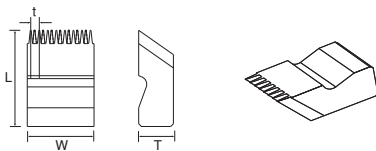

Order no.	Size			Finger joint length L [mm]	Pitch t [mm]	Number of fingers*	Type
	W [mm]	L [mm]	T [mm]				
1 778-A013-611	25	36	13	3.5/4.5	1.6	16	MZ

*Number of fingers when set in the head

Disc Type Cutter

HC-UP tipped Cutter

APPLICATION

Millwork finger joints

MACHINE

Batch feed and through feed machines

MATERIAL

Hardwoods, tropical woods

EDGE MATERIAL

HC-UP



※HC-UP coating requires a special resharping method
PAT.EP0739697

► Features & Benefits

- Heat treated body withstands bending
- Advanced Material Technology cutting edges outlast conventional tooling 3-5 times enabling longer machine run time and less grinds per month
- Cuts cleaner because of Advanced Material Technology

EDGE MATERIAL
HC-UP

► **Cutters**

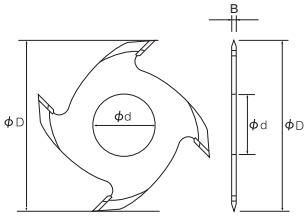

Order no.	Size				Finger joint length L [mm]	Pitch t [mm]	
	D [mm]	B [mm]	d [mm]	z			
1	160	3.8	70	4	10/11	3.8	
2 450-A653-470	160	3.8	70	2	10/11	3.8	
3 450-A662-470	160	7.6	70	4	10/11		
4 450-A663-470	160	11.4	70	4	10/11		
5 450-A615-470	250	3.8	70	6	10/11	3.8	
6 450-A664-470	250	15.2	70	6	10/11		

3

Planing

ENSHIN <i>Self-Locking Planer Head</i>	67
ENSHIN PowerLock-Type <i>Self-Locking Planer Head</i>	69
ENSHIN <i>Blades</i>	71
ENSHIN <i>Reference Engraver</i>	73
Planer Head with αMT coated inserts	75
Tersa[®]-System <i>Blades</i>	77
ST-1 <i>Planer Knives</i>	79
ST-1 Planer Head <i>Hydro Planer Head</i>	83



ENSHIN

Self-Locking Planer Head

APPLICATION

Fine and rough planing

MACHINE

4-side planer, moulder



Features & Benefits

- Unique centrifugal self locking system accurately locks the knives in place
- System is easy to handle and a complete knife change does not take longer than 2-3 min
- ENSHIN heads with chamfer or radius knives are available upon request



Tap the wedge gently

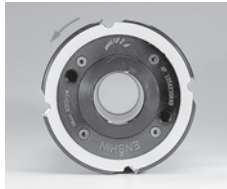

Turn the safety stopper ring



Slide out the knife



Clamp the setting block between head and clamping wedge to slide in the knife

N (rpm)	Z	S.R. (mm)	F (m/min)							
			1	5	10	15	20	25	30	35
6000	2	0.5	Ultra fine planing	Fine planing	Fine planing	Fine planing	Fine planing	Fine planing	Fine planing	Fine planing
		1	Ultra fine planing	Fine planing	Fine planing	Fine planing	Fine planing	Fine planing	Fine planing	Fine planing
		1.5	Ultra fine planing	Fine planing	Fine planing	Fine planing	Fine planing	Fine planing	Fine planing	Fine planing
		2	Ultra fine planing	Fine planing	Fine planing	Fine planing	Fine planing	Fine planing	Fine planing	Fine planing
		2.5	Ultra fine planing	Fine planing	Fine planing	Fine planing	Fine planing	Fine planing	Fine planing	Fine planing
	4	3	Ultra fine planing	Fine planing	Fine planing	Fine planing	Fine planing	Fine planing	Fine planing	Fine planing
		3.5	Ultra fine planing	Fine planing	Fine planing	Fine planing	Fine planing	Fine planing	Fine planing	Fine planing
		4	Ultra fine planing	Fine planing	Fine planing	Fine planing	Fine planing	Fine planing	Fine planing	Fine planing
		4.5	Ultra fine planing	Fine planing	Fine planing	Fine planing	Fine planing	Fine planing	Fine planing	Fine planing
		5	Ultra fine planing	Fine planing	Fine planing	Fine planing	Fine planing	Fine planing	Fine planing	Fine planing

N (rpm)	Z	S.R. (mm)	F (m/min)							
			1	5	10	15	20	25	30	35
8000	2	0.5	Ultra fine planing	Fine planing	Fine planing	Fine planing	Fine planing	Fine planing	Fine planing	Fine planing
		1	Ultra fine planing	Fine planing	Fine planing	Fine planing	Fine planing	Fine planing	Fine planing	Fine planing
		1.5	Ultra fine planing	Fine planing	Fine planing	Fine planing	Fine planing	Fine planing	Fine planing	Fine planing
		2	Ultra fine planing	Fine planing	Fine planing	Fine planing	Fine planing	Fine planing	Fine planing	Fine planing
		2.5	Ultra fine planing	Fine planing	Fine planing	Fine planing	Fine planing	Fine planing	Fine planing	Fine planing
	4	3	Ultra fine planing	Fine planing	Fine planing	Fine planing	Fine planing	Fine planing	Fine planing	Fine planing
		3.5	Ultra fine planing	Fine planing	Fine planing	Fine planing	Fine planing	Fine planing	Fine planing	Fine planing
		4	Ultra fine planing	Fine planing	Fine planing	Fine planing	Fine planing	Fine planing	Fine planing	Fine planing
		4.5	Ultra fine planing	Fine planing	Fine planing	Fine planing	Fine planing	Fine planing	Fine planing	Fine planing
		5	Ultra fine planing	Fine planing	Fine planing	Fine planing	Fine planing	Fine planing	Fine planing	Fine planing

Ultra fine planing
 Fine planing
 Rough planing

▶ ENSHIN Bore Type

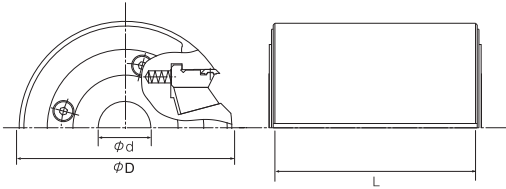

Order no.	Size				n max [1/min]
	D [mm]	L [mm]	d [mm]	z	
1 789-B375-500	125	100	40	4	8000
2 789-A869-500	125	130	40	4	8000
3 789-B078-500	125	150	40	4	8000
4 789-A868-500	125	180	40	4	8000
5 789-A866-500	125	230	40	4	8000
6 789-B630-500	125	100	1 1/2"	4	8000
7 789-B638-500	125	130	1 1/2"	4	8000
8 789-B637-500	125	150	1 1/2"	4	8000
9 789-B636-500	125	230	1 1/2"	4	8000

For up to 8000 RPM it is also possible to mount a regular bore type ENSHIN onto an arbor with PowerLock interface.

After secure assembly of the arbor and the ENSHIN, the entire system is balanced in order to ensure highest planing quality and work safety.

Regular arbors and hydro arbors are available. For more details please contact Kanefusa.

▶ ENSHIN PowerLock-Type

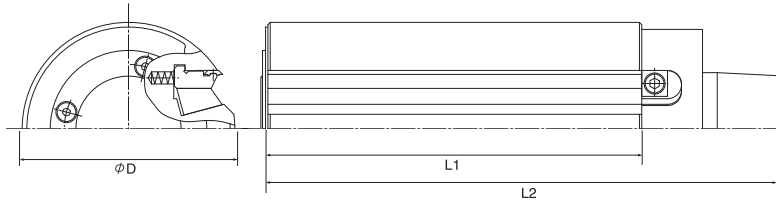

Order no.	Size				n max [1/min]	Type
	D [mm]	L1 [mm]	L2 [mm]	z		
1 788-1213-500	90	80	138	2	12500	Left/Below
2 788-1255-500	90	100	158	2	12500	Left/Below
3 788-1073-500	90	130	188	2	12500	Left/Below
4 788-1297-500	90	150	208	2	12500	Left/Below
5 788-1114-500	90	170	228	2	12500	Left/Below
6 788-1338-500	90	190	248	2	12500	Below
7 788-1370-500	90	210	268	2	12500	Below
8 788-1156-500	90	240	298	2	12500	Below
9 788-1239-500	90	80	138	2	12500	Right/Above
10 788-1271-500	90	100	158	2	12500	Right/Above
11 788-1081-500	90	130	188	2	12500	Right/Above
12 788-1312-500	90	150	208	2	12500	Right/Above
13 788-1122-500	90	170	228	2	12500	Right/Above
14 788-1396-500	90	210	268	2	12500	Above
15 788-1164-500	90	240	298	2	12500	Above

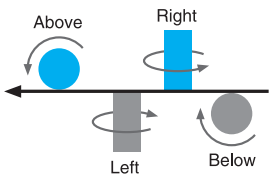

The body diameter (D) of the PowerLock ENSHIN is 90 mm. The mono-block body is pre-manufactured by Weing S.A. of Switzerland and completed by Kanefusa Corporation Japan. This ensures a highest standard in precision and quality.

Equipped with HS-HP knives, the outer tool diameter will be 92 mm. Because HW knives are wider, the outer tool diameter will be 92.7 mm. Either diameter fits Powermat machines.

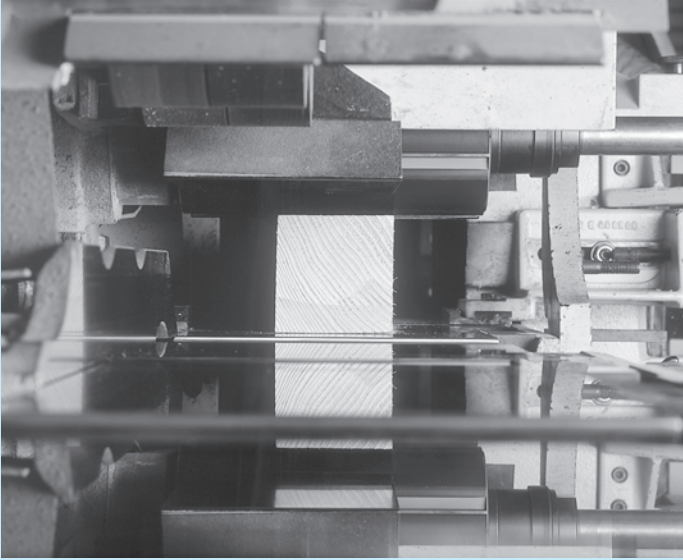

ENSHIN

Blades

APPLICATION

For use in ENSHIN planer heads

MATERIAL

Softwoods, hardwoods, tropical woods,
Plastic resin

EDGE MATERIAL

HS-HP (softwoods)
HW (hardwoods, tropical woods, plastic resin)

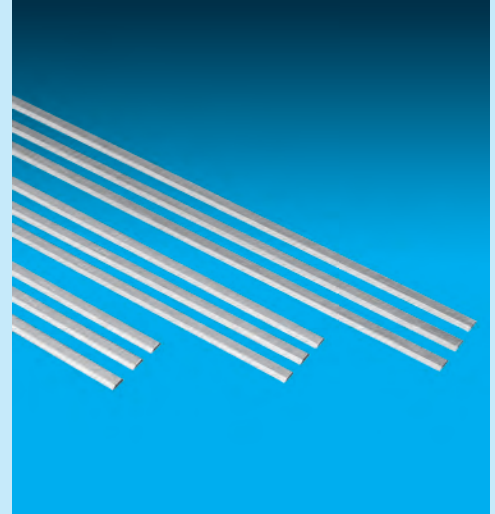

※HS-HP coating requires a special sharpening method

► Features & Benefits

- Every knife has two cutting edges of reversible design, which makes the ENSHIN a very economical tool
- Knife quality HS-HP provides up to 5 times longer edge life compared with regular HSS knives
- For planning of hardwoods and tropical timber, carbide knives provide excellent lifetime
- Every knife has a chip breaker and fine lapped cutting edge for smooth surfaces even cutting against the grain
- HS-HP knives are for single use. No edge life reduction and inconsistent cut after grinding

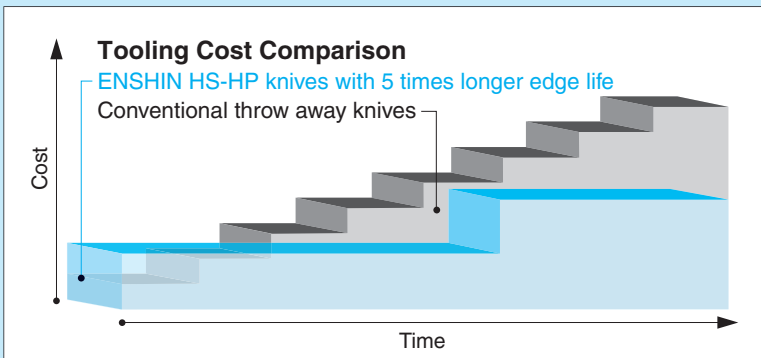

EDGE MATERIAL
HS-HP, HW

▶ **ENSHIN Knives**

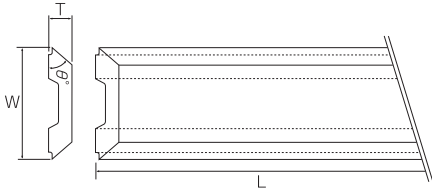

Order no.	Size			Grade
	L [mm]	W [mm]	T [mm]	
1 797-A483-611	80	12	2.6	HS-HP
2 797-1022-611	100	12	2.6	HS-HP
3 797-1329-611	130	12	2.6	HS-HP
4 797-1527-611	150	12	2.6	HS-HP
5 797-A527-611	170	12	2.6	HS-HP
6 797-1824-611	180	12	2.6	HS-HP
7 797-1923-611	190	12	2.6	HS-HP
8 797-2129-611	210	12	2.6	HS-HP
9 797-2327-611	230	12	2.6	HS-HP
10 797-A595-611	240	12	2.6	HS-HP
<hr/>				
11 797-A423-900	80	12.7	2.6	HW
12 797-A452-900	100	12.7	2.6	HW
13 797-A435-900	130	12.7	2.6	HW
14 797-A443-900	150	12.7	2.6	HW
15 797-A528-900	170	12.7	2.6	HW
16 797-A436-900	180	12.7	2.6	HW
17 797-A470-900	190	12.7	2.6	HW
18 797-A505-900	210	12.7	2.6	HW
19 797-A351-900	230	12.7	2.6	HW
20 797-A481-900	240	12.7	2.6	HW

EDGE MATERIAL
HC-UP

► **Rebating Reference Engraver Head**

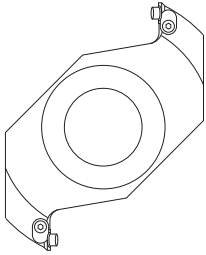

Order no.	Size			
	D [mm]	B [mm]	d [mm]	z
1 877-C055-400	140	× 12	× 40	× 2
2 877-0000-400	145	× 12	× 1 1/2"	× 2

► **Knives for Reference Engraver**

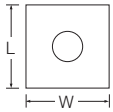

Order no.	Size			Grade
	L [mm]	W [mm]	T [mm]	
1 781-1210-901	12	× 12	× 1.5	HC-UP

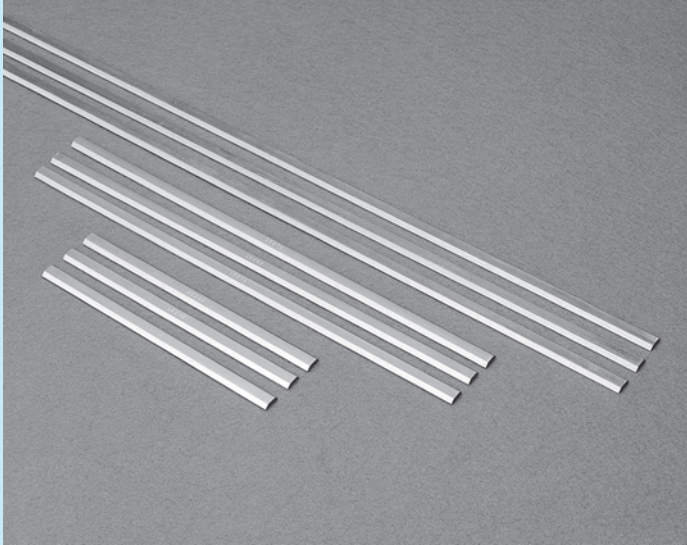

Planer Head with α MT coated inserts

APPLICATION

Planing on solid wood material

MACHINE

Planer and Moulder machine

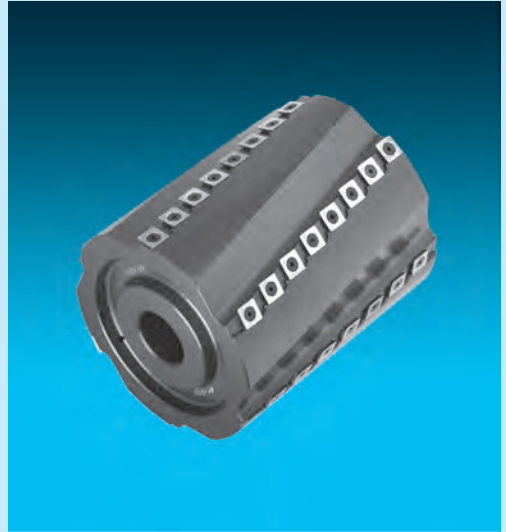

► Features & Benefits

- Superb effect on Heavy duty and low noise planing
- Special coated carbide inserts are spirally set for noise reduction both in idling and cutting and for less cutting resistance good for heavy duty cutting
- Carbide inserts are tough against glue lines on laminated timber
- Carbide inserts are economical due to four cutting edges

▶ Planer Head with α MT coated inserts

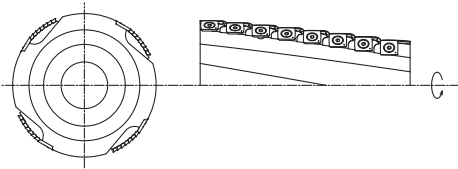

Order no.	Size						
	D [mm]		L [mm]		d [mm]		z
1	125	×	130	×	40	×	4
2	125	×	160	×	40	×	4
3	125	×	180	×	40	×	4

Maximum length of this cutter head is 180mm

Tersa[®]-System

Blades

APPLICATION

For use in planer heads

MATERIAL

Softwoods, hardwoods, tropical woods

EDGE MATERIAL

HS-HP (softwoods)

※HS-HP coating requires a special resharpener method

Tersa[®] is a registered trademark of Samvaz S.A.
Kanefusa Corporation makes no claim of ownership to this trademark

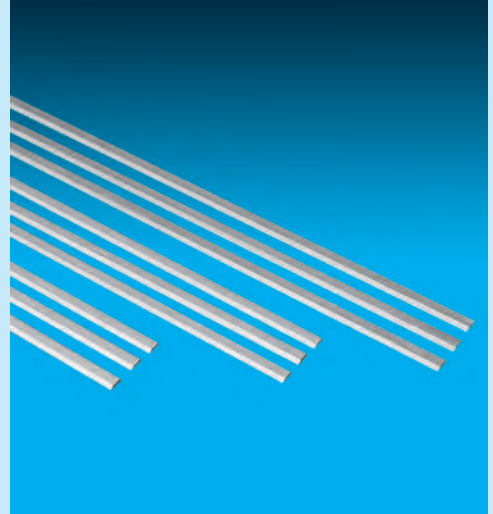

► Features & Benefits

- Every knife has two cutting edges of reversible design, which makes very economical tool
- Knife quality HS-HP provides up to 5 times longer edge life compared with regular HSS knives
- Every knife has a chip breaker and fine lapped cutting edge for smooth surfaces even cutting against the grain
- HS-HP knives are for single use. No edge life reduction and inconsistent cut after grinding

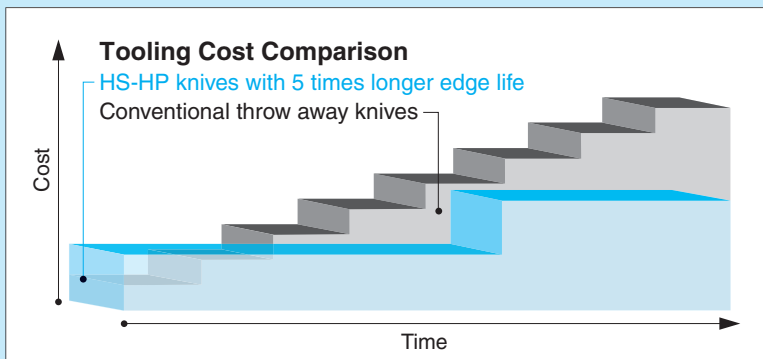

EDGE MATERIAL
HS-HP

► Knives for Tersa®-System Planer Heads



Tersa® is a registered trademark of Samvaz S.A. Kanefusa Corporation makes no claim of ownership to this trademark

Order no.	Size			Grade
	L [mm]	W [mm]	T [mm]	
1 797-A516-611	130	10	2.3	HS-HP
2 797-A518-611	180	10	2.3	HS-HP
3 797-A517-611	230	10	2.3	HS-HP
4 797-7955-611	650	10	2.3	HS-HP

※other lengths are available upon request.

ST-1

Planer Knives

APPLICATION

High speed planing and regular planing

MATERIAL

Softwoods, hardwoods

EDGE MATERIAL

HS-HP



※HS-HP coating requires a special sharpening method

Features & Benefits

- Knife quality HS-HP provides up to 5 times longer edge life compared with regular HSS knives
- Longer lifetime increases machine run time and reduces grinding cost
- Because of its self-resharpening properties, consistent high surface quality is achieved, reducing or even eliminating subsequent sanding
- Provides high process reliability

Efficiency study at a user in Austria

Knife Grade	HSS	ST-1	Knife Grade	HSS	ST-1
Head removals per week	15	3	Regrinds per week	15	3
Set up time [min.]	15	15	Time per regrind [min.]	90	90
Set up time per week [min.]	225	45	Grinding time per week [min.]	1350	270
Set up time per year [hours] (46 weeks)	172.5	35	Grinding time per year [hours] (46 weeks)	1035	207
Time saving per year [hours]		138	Time saving per year [hours]		828

Total time saving per year = 966 hours

The user identified following advantages

- Enormous annual gain in machine uptime
- Drastic reduction of grinding cost
- Much better surface finish
- Increase of feed rate by 8 m /min
- High process reliability and better coordination of work flow due to less machine stops for head removal

EDGE MATERIAL
HS-HP

▶ **ST-1 Flat Knives**

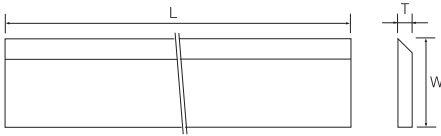

Order no.	L [mm]	Size W [mm]	T [mm]
1 030-D294-619	60	30	3
2 030-B515-619	75	30	3
3 030-B461-619	80	30	3
4 030-B514-619	90	30	3
5 030-C676-619	100	30	3
6 030-C551-619	110	30	3
7 030-C722-619	120	30	3
8 030-D466-619	125	30	3
9 030-C721-619	130	30	3
10 030-D381-619	155	30	3
11 030-C415-619	160	30	3
12 030-C550-619	170	30	3
13 030-C269-619	180	30	3
14 030-C825-619	185	30	3
15 030-C510-619	200	30	3
16 030-C010-619	210	30	3
17 030-C804-619	215	30	3
18 030-B464-619	220	30	3
19 030-C359-619	230	30	3
20 030-C182-619	235	30	3
21 030-C459-619	240	30	3
22 030-C514-619	250	30	3
23 030-C369-619	255	30	3
24 030-C135-619	260	30	3
25 030-D410-619	265	30	3

Order no.	L [mm]	Size W [mm]	T [mm]
26 030-0000-619	270	30	3
27 030-C723-619	280	30	3
28 030-C517-619	300	30	3
29 030-C358-619	310	30	3
30 030-C994-619	320	30	3
31 030-C495-619	330	30	3
32 030-C979-619	380	30	3
33 030-C985-619	410	30	3
34 030-D072-619	420	30	3
35 030-C806-619	460	30	3
36 030-E138-619	480	30	3
37 030-C265-619	510	30	3
38 030-C706-619	660	30	3
39 030-D384-619	40	35	3
40 030-C877-619	60	35	3
41 030-B457-619	80	35	3
42 030-C379-619	100	35	3
43 030-D344-619	120	35	3
44 030-C700-619	130	35	3
45 030-C476-619	135	35	3
46 030-0000-619	150	35	3
47 030-C382-619	160	35	3
48 030-E139-619	170	35	3
49 030-C461-619	180	35	3
50 030-D423-619	190	35	3

※other lengths are available upon request.

EDGE MATERIAL
HS-HP

▶ **ST-1 Flat Knives**

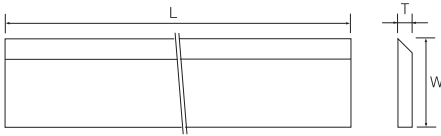

Order no.	L [mm]	Size W [mm]	T [mm]
51 030-D312-619	200	35	3
52 030-C475-619	210	35	3
53 030-C250-619	230	35	3
54 030-C101-619	235	35	3
55 030-C708-619	240	35	3
56 030-D177-619	255	35	3
57 030-C050-619	260	35	3
58 030-D422-619	270	35	3
59 030-E140-619	303	35	3
60 030-E107-619	310	35	3
61 030-C493-619	320	35	3
62 030-C134-619	330	35	3
63 030-D619-619	370	35	3
64 030-D209-619	380	35	3
65 030-C773-619	400	35	3
66 030-D202-619	410	35	3
67 030-D037-619	480	35	3
68 030-C264-619	500	35	3
69 030-0000-619	510	35	3
70 030-C345-619	520	35	3
71 030-C796-619	530	35	3
72 030-C560-619	635	35	3
73 030-E147-619	660	35	3
74 030-E573-619	130.2	50.8	3.96
75 030-E523-619	165.1	50.8	3.96

Order no.	L [mm]	Size W [mm]	T [mm]
76 030-E520-619	203.2	50.8	3.96
77 030-E522-619	254	50.8	3.96
78 030-E521-619	304.8	50.8	3.96
79 030-E519-619	330.2	50.8	3.96
80 030-E566-619	381	50.8	3.96
81 030-E510-619	381	50	4

※other lengths are available upon request.



ST-1 Planer Head

Hydro Planer Head

APPLICATION

Knife carrier for ST-1 flat knives

MACHINE

Moulder



► Features & Benefits

- Body is made from Steel
- Reduces the play between spindle and head enabling a truer running of the head
- Pressurized with a grease pump

The available size is 125-250mm in diameter and 100-300mm in length for 2-12 knives

► For Knife Size 35x3

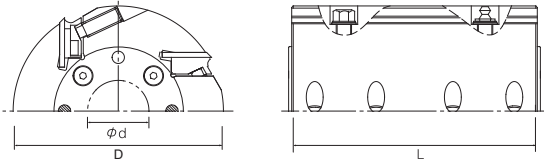

Order no.	Size				n max [1/min]
	D [mm]	L [mm]	d [mm]	z	
1	180	100	40	8	7200
2	180	160	40	8	7200
3	180	230	40	8	7200
4	180	100	40	10	7200
5	180	160	40	10	7200
6	180	230	40	10	7200
7	203	100	50	6	6400
8	203	160	50	6	6400
9	203	230	50	6	6400
10	203	320	50	6	6400
11	203	100	50	8	6400
12	203	160	50	8	6400
13	203	230	50	8	6400
14	203	320	50	8	6400
15	203	100	50	10	6400
16	203	160	50	10	6400
17	203	230	50	10	6400
18	203	320	50	10	6400
19	203	100	50	12	6400
20	203	160	50	12	6400
21	203	230	50	12	6400
22	203	320	50	12	6400
23	225	100	45	10	5800
24	225	160	45	10	5800
25	225	230	45	10	5800

► For Knife Size 35x3

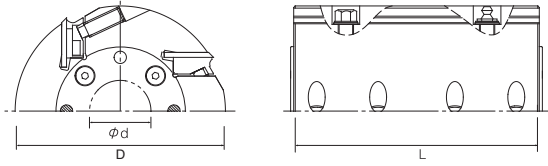

Order no.	Size				n max [1/min]
	D [mm]	L [mm]	d [mm]	z	
26	225	100	40	12	5800
27	225	160	40	12	5800
28	225	230	40	12	5800

► For Knife Size 30x3

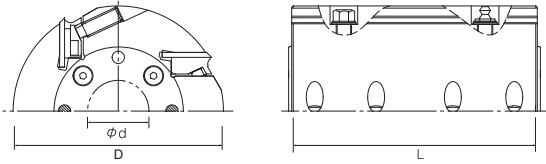

Order no.	Size				n max [1/min]
	D [mm]	L [mm]	d [mm]	z	
1	143	160	40	4	9100
2	143	230	40	4	9100
3	163	100	50	4	8000
4	163	130	50	4	8000
5	163	160	50	4	8000
6	163	230	50	4	8000
7	163	260	50	4	8000
8	163	100	50	6	8000
9	163	130	50	6	8000
10	163	160	50	6	8000
11	163	230	50	6	8000
12	163	260	50	6	8000
13	163	100	50	8	8000
14	163	160	50	8	8000
15	163	230	50	8	8000
16	203	230	50	8	6400
17	203	150	50	10	6400

4

Profiling

ST-1 <i>Corrugated Back Knives</i>	89
ST-1 Knife Head <i>PowerLock Type</i>	91
SF-Splitting Technology <i>HC-UP tipped Cutter</i>	93
SF-Tongue and Groove Cutter <i>HC-UP tipped Cutter</i>	95
SF-Radius and Chamfer Cutter <i>HC-UP tipped Cutter</i>	97
SF-Panel Raise Cutter <i>HC-UP tipped Cutter</i>	99
SF-Profile Cutter <i>HC-UP tipped Cutter</i>	101



Profiling

ST-1

Corrugated Back Knives

APPLICATION

Profiling

MATERIAL

Softwoods, hardwoods

EDGE MATERIAL

HS-HP

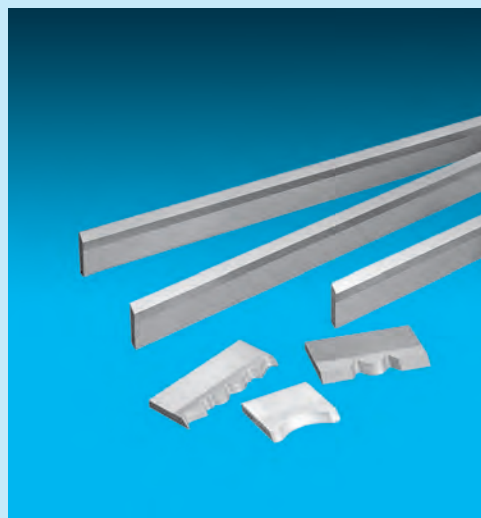

※HS-HP coating requires a special sharpening method

► Features & Benefits

- Knife quality HS-HP provides up to 5 times longer edge life compared with regular HSS knives
- Longer lifetime increases machine run time and reduces grinding cost
- Because of its self-resharpening properties, consistent high surface quality is achieved reducing or even eliminating subsequent sanding
- Guarantees high process reliability
- Easier to grind than carbide knives

EDGE MATERIAL
HS-HP

▶ **ST-1 Corrugated Back Knives**

▶ **ST-1 Corrugated Back Knives**

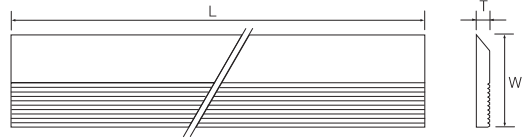
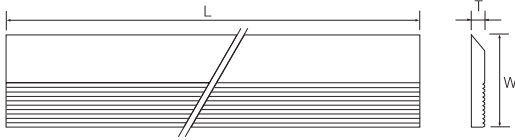

Order no.	L [mm]	Size W [mm]	T [mm]
1 777-A269-619	40	50	8
2 777-A251-619	60	50	8
3 777-A249-619	80	50	8
4 777-A221-619	100	50	8
5 777-A344-619	130	50	8
6 777-A465-619	150	50	8
7 777-A508-619	180	50	8
8 777-A467-619	210	50	8
9 777-A468-619	260	50	8
10 777-A469-619	310	50	8
11 777-A470-619	460	50	8
12 777-A245-619	635	50	8
13 777-A270-619	40	60	8
14 777-A228-619	60	60	8
15 777-A271-619	80	60	8
16 777-A212-619	100	60	8
17 777-A140-619	130	60	8
18 777-A280-619	150	60	8
19 777-A471-619	180	60	8
20 777-A472-619	210	60	8
21 777-A473-619	260	60	8
22 777-A474-619	310	60	8
23 777-A475-619	460	60	8
24 777-A243-619	635	60	8
25 777-A158-619	60	70	8

Order no.	L [mm]	Size W [mm]	T [mm]
26 777-A476-619	80	70	8
27 777-A394-619	100	70	8
28 777-0000-619	130	70	8
29 777-A478-619	150	70	8
30 777-A479-619	180	70	8
31 777-A480-619	210	70	8
32 777-A481-619	310	70	8
33 777-A482-619	460	70	8
34 777-A211-619	635	70	8
35 777-A552-619	165.1	50.8	6.35
36 777-A555-619	177.8	31.75	3.9

※other lengths are available upon request.

※other lengths are available upon request.

ST-1 Knife Head

PowerLock Type

APPLICATION

Knife carrier for ST-1 corrugated back knives

MACHINE

Powermat

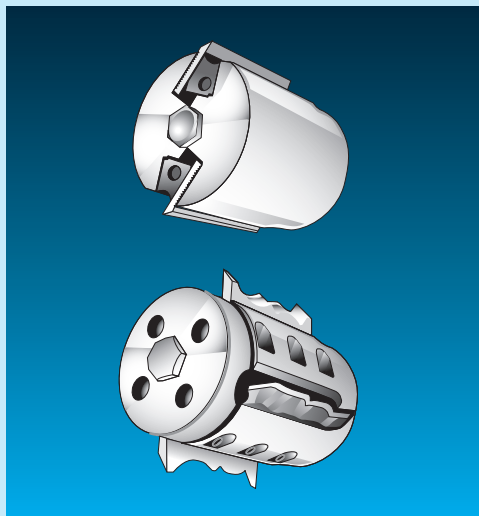

Head are manufactured by Michael Weing AG

▶ CentroLock Head

- For use with ST-1 knives
- Available with hook angle 20° for softwood and 12° for hardwood
- Maximum allowable operation speed is 12000 rpm
- Quick and easy knife change
- Tool run out is less then 0.01 mm when the knives are ground inside the head

▶ Planing and Profiling Head

- For use with ST-1 knives
- Available with hook angle 20° for softwood and 12° for hardwood
- Maximum allowable operation speed is 12000 rpm
- Tool run out is less then 0.005 mm when the knives are ground inside the head

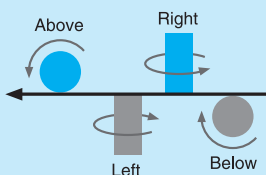

▶ CentroLock Planing and Profiling Heads

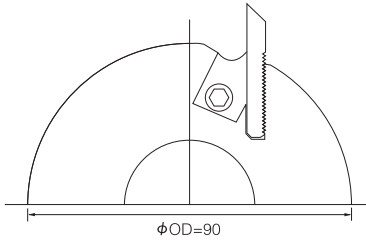

Order no.	D [mm]	Size L [mm]	z
1	90	60	2 & 4
2	90	80	2 & 4
3	90	100	2 & 4
4	90	130	2 & 4
5	90	150	2 & 4
6	90	170	2 & 4
7	90	190	2 & 4
8	90	210	2 & 4
9	90	240	2 & 4

▶ Planing and Profiling Heads

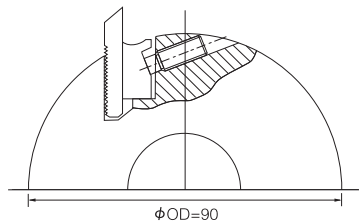

Order no.	D [mm]	Size L [mm]	z
1	90	60	2
2	90	80	2
3	90	100	2
4	90	130	2
5	90	150	2
6	90	170	2
7	90	190	2
8	90	210	2
9	90	240	2

SF-Splitting Technology

HC-UP tipped Cutter

APPLICATION

Profiling of a single piece, which is cut into multiple pieces on the last spindle of high speed planer

MACHINE

Planer

MATERIAL

Softwoods, hardwoods, tropicalwoods

EDGE MATERIAL

HC-UP

※HC-UP coating requires a special resharping method
PAT.EP0739697



Features & Benefits

- Combination of SF-saw blade and profile cutter
- Finish cut quality allows to reduce subsequent planing or sanding for tremendous cost savings
- Works perfectly at feed over 100m /min
- Should be used with hydro sleeve

1st vertical profiling of the left and right side

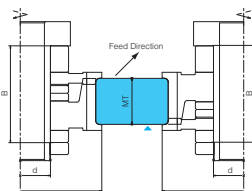
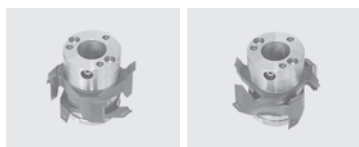

2nd horizontal profiling top side

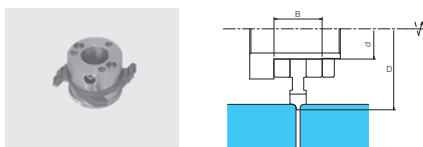

3rd horizontal profiling bottom side and splitting

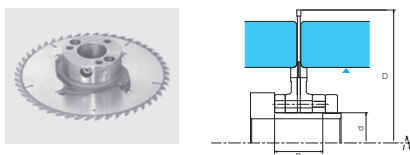

EDGE MATERIAL
HC-UP

► SF-Splitting Technology

Vertical Profiling Cutter	Size				Material thickness [mm]
	D [mm]	d [mm]	B [mm]	z	
1 Radius 3mm	180	59.96	50	4+4	25.4-44.5
2 Chamfer 3mm x 45°	180	59.96	50	4+4	25.4-44.5
3 Radius 3mm	180	59.96	50	8	38.1
4 Chamfer 3mm x 45°	180	59.96	50	8	38.1
5 Radius 3mm	180	59.96	50	8	44.5
6 Chamfer 3mm x 45°	180	59.96	50	8	44.5

Horizontal Profiling Cutter	Size			
	D [mm]	d [mm]	B [mm]	z
1 Radius 3mm	180	59.96	50	4
2 Chamfer 3mm x 45°	180	59.96	50	4
3 Radius 3mm	180	59.96	50	8
4 Chamfer 3mm x 45°	180	59.96	50	8

Horizontal Splitting and Profiling Cutter	Size				Kerf SF-saw [mm]	Material thickness [mm]
	D [mm]	d [mm]	B [mm]	z		
1 Radius 3mm	250	59.96	50	4+20+4	3	25.4-44.5
2 Chamfer 3mm x 45°	250	59.96	50	4+20+4	3	25.4-44.5
3 Radius 3mm	225	59.96	50	8+24+8	3	38.1
4 Radius 3mm	250	59.96	50	8+24+8	3	44.5
5 Chamfer 3mm x 45°	225	59.96	50	8+24+8	3	38.1
6 Radius 3mm	250	59.96	50	4+20+4	3	25.4-44.5
7 Chamfer 3mm x 45°	250	59.96	50	4+20+4	3	25.4-44.5
8 Radius 3mm	225	59.96	50	8+24+8	3	38.1
9 Radius 3mm	250	59.96	50	8+24+8	3	44.5
10 Chamfer 3mm x 45°	225	59.96	50	8+24+8	3	38.1

SF-Tongue and Groove Cutter

HC-UP tipped Cutter

APPLICATION

Solid wood floor and wainscot manufacturing

MACHINE

Moulder

MATERIAL

Softwoods, hardwoods, tropicalwoods

EDGE MATERIAL

HC-UP

※HC-UP coating requires a special resharpening method
PAT.EP0739697

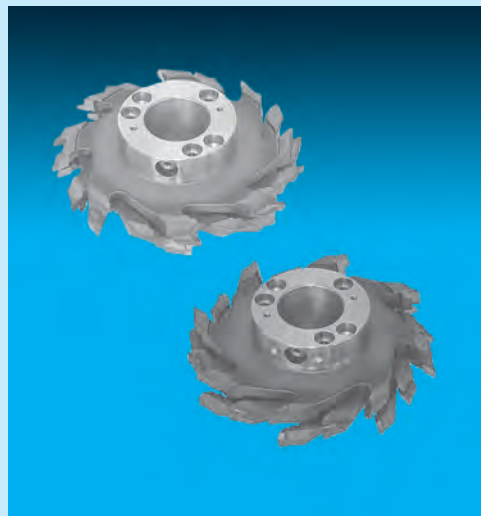

Features & Benefits

- Outlasts conventional tooling 3-5 times enabling longer machine run times and fewer regrinds
- Cuts cleaner than conventional tooling allowing to reduce further sanding
- Should be used with a hydro sleeve

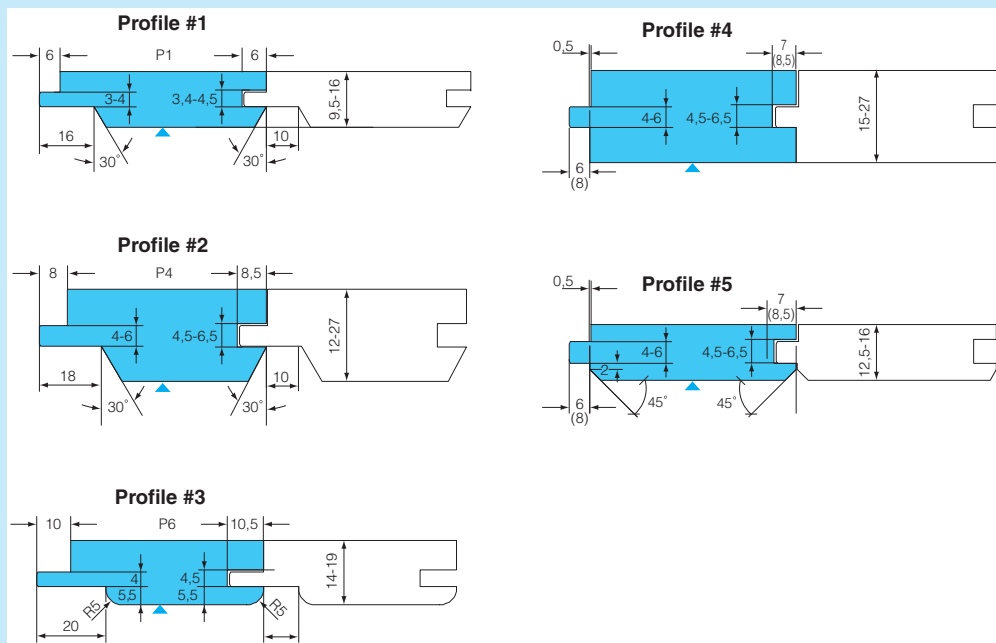

EDGE MATERIAL
HC-UP

► **SF-Tongue and Groove Cutter**

Profile no.	D [mm]	Size d [mm]	z	Material thickness [mm]	Feed rate* [m/min]	RPM* [1/min]
1	1	180 × 60	6+6	9.5–16	30–45	6000
2	2	180 × 60	6+6	12.0–27.0	30–45	6000
3	3	180 × 60	6+6	12.0–19.0	30–45	6000
4	4	180 × 60	6+6	15–27	30–45	6000
5	5	180 × 60	6+6	12.5–16	30–45	6000

* Recommended

※other specifications are available upon request.

SF-Radius and Chamfer Cutter

HC-UP tipped Cutter

APPLICATION

Wainscot manufacturing

MACHINE

Moulder

MATERIAL

Softwoods, hardwoods, tropicalwoods

EDGE MATERIAL

HC-UP

※HC-UP coating requires a special resharpening method
PAT.EP0739697

Features & Benefits

- Outlasts conventional tooling 3-5 times enabling longer machine run times and fewer regrinds
- Cuts cleaner than conventional tooling, allowing to reduce further sanding
- Should be used with a hydro sleeve

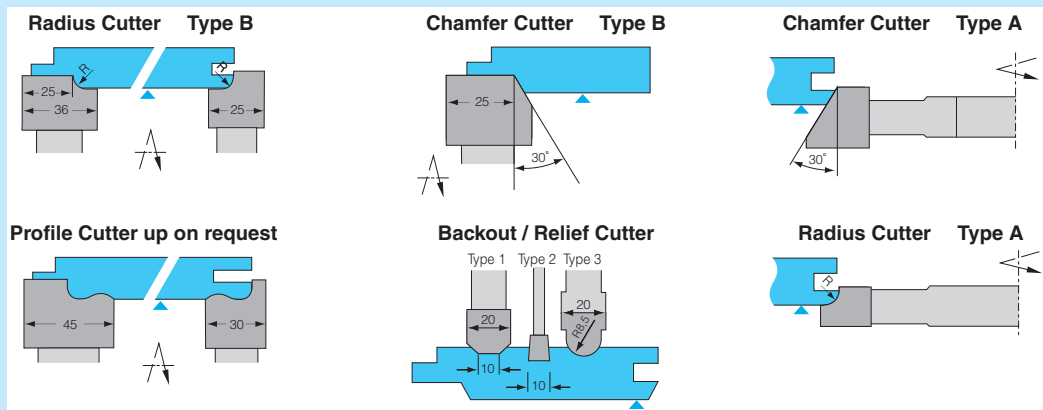

EDGE MATERIAL
HC-UP

► **SF-Radius and Chamfer Cutter**

		Size				Feed rate* [m/min]	RPM* [1/min]
		D [mm]	B [mm]	d [mm]	z		
Chamfer Cutter Type A							
1		240	× 30	× 60	× 6	30-50	6000
Radius Cutter Type A							
1	R5	240	× 20	× 60	× 6	30-50	6000
2	R6	240	× 20	× 60	× 6	30-50	6000
3	R7	240	× 20	× 60	× 6	30-50	6000
4	R8	240	× 20	× 60	× 6	30-50	6000
Backout/Relief Cutter							
1	Type1	200	× 20	× 60	× 6	30-50	6000
2	Type2	200	× 10	× 60	× 12	30-50	6000
3	Type3	200	× 20	× 60	× 6	30-50	6000
Chamfer Cutter Type B							
1		200	× 35	× 60	× 6	30-50	6000
Radius Cutter Type B							
1	R5-groove side	200	× 20	× 60	× 6	30-50	6000
2	R6-groove side	200	× 20	× 60	× 6	30-50	6000
3	R7-groove side	200	× 20	× 60	× 6	30-50	6000
4	R8-groove side	200	× 20	× 60	× 6	30-50	6000
5	R5-tongue side	200	× 35	× 60	× 6	30-50	6000
6	R6-tongue side	200	× 35	× 60	× 6	30-50	6000
7	R7-tongue side	200	× 35	× 60	× 6	30-50	6000
8	R8-tongue side	200	× 35	× 60	× 6	30-50	6000

* Recommended

※other specifications are available upon request.

SF-Panel Raise Cutter

HC-UP tipped Cutter

APPLICATION

Panel raising in exterior door, interior door and cabinet door manufacturing

MACHINE

Moulder, Tenoner

MATERIAL

Softwoods, hardwoods, tropicalwoods

EDGE MATERIAL

HC-UP

※HC-UP coating requires a special resharping method
PAT.EP0739697



Features & Benefits

- Outlasts conventional tooling 3-5 times enabling longer machine run times and fewer regrinds
- Cuts cleaner than conventional tooling allowing to reduce further sanding
- Should be used with a hydro sleeve

Standard Profiles

Profile # 1-S

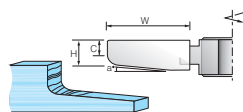

Profile # 1-D

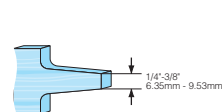

Profile # 2-S

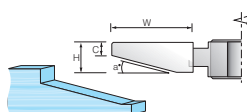

Profile # 2-D

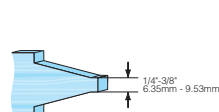

Profile # 3-S

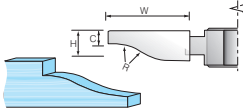

Profile # 3-D

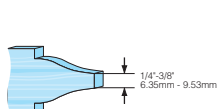

Profile # 4-S

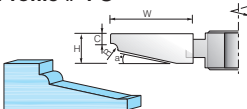

Profile # 4-D

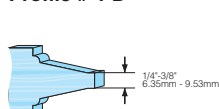

Profile # 5-S

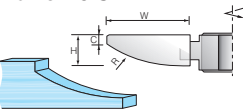

Profile # 5-D

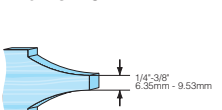

EDGE MATERIAL
HC-UP

► SF-Panel Raise Cutter

Profile no.	Sense of rotation	Size				Feed rate* [m/min]	RPM* [1/min]	
		D [mm]	B [mm]	d [mm]	z			
1	1-S	counter clockwise	200	22.5	60	6	15-20	6000
2	2-S	counter clockwise	200	22.5	60	6	15-20	6000
3	3-S	counter clockwise	200	22.5	60	6	15-20	6000
4	4-S	counter clockwise	200	22.5	60	6	15-20	6000
5	5-S	counter clockwise	200	22.5	60	6	15-20	6000
6	1-S	clockwise	200	22.5	60	6	15-20	6000
7	2-S	clockwise	200	22.5	60	6	15-20	6000
8	3-S	clockwise	200	22.5	60	6	15-20	6000
9	4-S	clockwise	200	22.5	60	6	15-20	6000
10	5-S	clockwise	200	22.5	60	6	15-20	6000

Profile no.	Adjustment range [mm]	Size				Feed rate* [m/min]	RPM* [1/min]	
		D [mm]	B [mm]	d [mm]	z			
11	1-D	5	200	50	60	6+6	15-20	6000
12	2-D	5	200	50	60	6+6	15-20	6000
13	3-D	5	200	50	60	6+6	15-20	6000
14	4-D	5	200	50	60	6+6	15-20	6000
15	5-D	5	200	50	60	6+6	15-20	6000

* Recommended

※ other specifications are available upon request.

SF-Profile Cutter

HC-UP tipped Cutter

APPLICATION

Profiling of solid wood

MACHINE

Moulder, tenoner

MATERIAL

Softwoods, hardwoods

EDGE MATERIAL

HC-UP

※HC-UP coating requires a special resharpener method
PAT.EP0739697



Features & Benefits

- Outlasts conventional tooling 3-5 times enabling longer machine run times and fewer regrinds
- Cuts cleaner (Super Finish) than conventional tooling allowing to reduce further sanding
- Should be used with a hydro sleeve

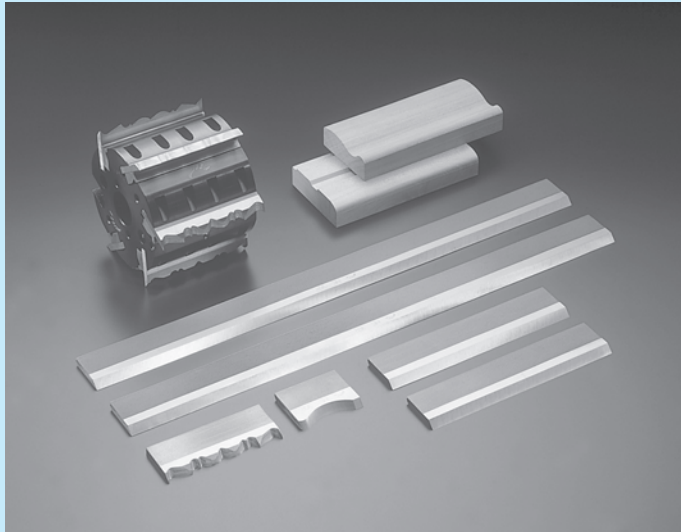

5

Routing

E-Bit <i>Solid HC-UP Bit</i>	105
SF-Router Bit <i>HC-UP tipped Router Bit</i>	107
Acryl-Bit <i>Mirror Finish Router Bit</i>	111
Cosmo-Bit <i>PCD tipped Router Bit</i>	113



Routing

E-Bit

Solid HC-UP Bit

APPLICATION

Precutting of solid wood

MACHINE

CNC router machine

MATERIAL

Softwoods, hardwoods

EDGE MATERIAL

HC-UP

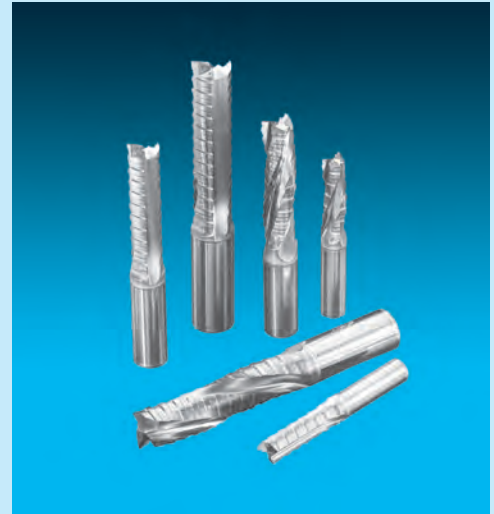

※HC-UP coating requires a special resharpening method
PAT.EP0739697

Features & Benefits

- Outlasts conventional bits between 3-5 times
- Due to less residue adhesion and the self-resharpening effect of Advanced Material Technology, higher feed is possible
- Unique tooth design for large stock removal but a very smooth finish at the same time
- Best performance with Hydro-Mechanical Precision Chuck

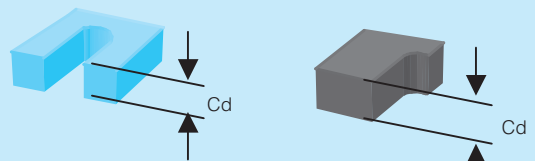
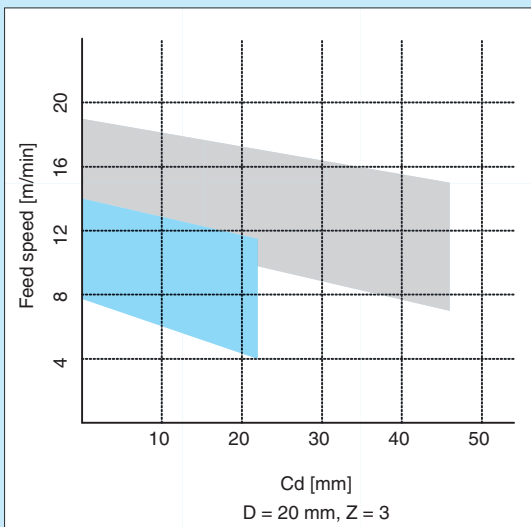

RPM: 14000 1/min – 18000 1/min

Values are only guidelines!
For maximum performance, accurate clamping of the tool and the work material as well as good machine condition and chip exhaustion are absolutely essential.

EDGE MATERIAL
HC-UP

► **E-Bit (straight)**

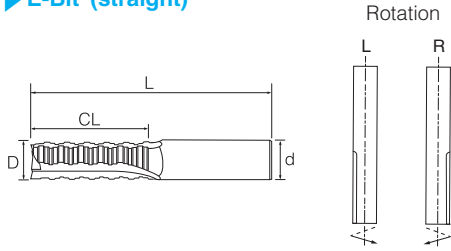

Order no.	d [mm]	D [mm]	Size L [mm]	CL [mm]	z	Type	Rotation
1 866-A645-901	10	10	80	30	2	Straight	R
2 866-3793-901	12	12	85	35	3	Straight	R
3 866-A603-901	12	12	95	45	3	Straight	R
4 866-A638-901	16	16	95	25	3	Straight	R
5 866-0000-901	16	16	110	55	3	Straight	R
6 866-0000-901	18	18	120	55	3	Straight	R
7 866-A564-901	20	20	110	55	3	Straight	R
8 866-0000-901	20	20	120	60	3	Straight	R
9 866-0000-901	20	20	135	75	3	Straight	R

※other specifications are available upon request.

► **E-Bit (spiral)**

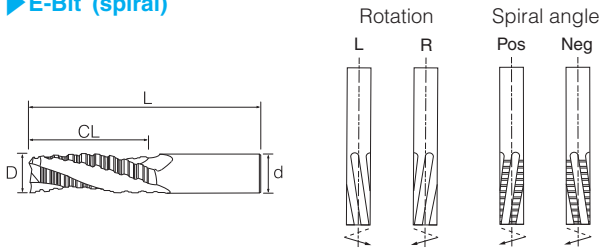

Order no.	d [mm]	D [mm]	Size L [mm]	CL [mm]	z	Type	Rotation
11 866-A568-901	12	12	95	45	3	Spiral	R/Pos.
12 866-A566-901	16	14	165	30	3	Spiral	R/Pos.
13 866-A690-901	16	16	110	55	3	Spiral	R/Pos.
14 866-A565-901	20	20	110	55	3	Spiral	R/Pos.
15 866-0000-901	20	20	120	60	3	Spiral	R/Pos.
16 866-A579-901	20	20	135	75	3	Spiral	R/Pos.

※other specifications are available upon request.

SF-Router Bit

HC-UP tipped Router Bit

APPLICATION

Chair and furniture production

MACHINE

CNC router machine

MATERIAL

Softwoods, hardwoods

EDGE MATERIAL

HC-UP

※HC-UP coating requires a special sharpening method
PAT.EP0739697

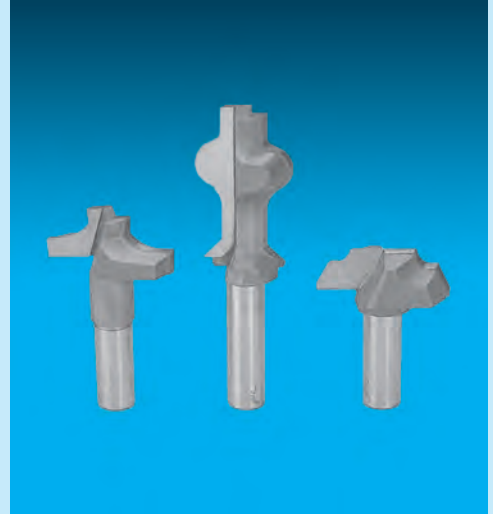

► Features & Benefits

- Cuts the fibers clean and smooth even on end grain
- Outlasts conventional tooling 3-5 times
- Guarantees high process reliability and better quality rates
- Best performance with a Hydro-Mechanical Precision Chuck

EDGE MATERIAL
HC-UP

► SF-Router Bit

Profile no.	D	a	Size						L [mm]
			R1 [mm]	R2 [mm]	B [mm]	B1 [mm]	d [mm]		
1	1	38.0 ×	×	×	×	10.0 ×	×	20.0 ×	76.0
2	2	70.0 ×	×	16.0 ×	×	30.0 ×	×	20.0 ×	90.0
3	3	70.0 ×	×	9.5 ×	×	25.0 ×	×	20.0 ×	90.0
4	4	70.0 ×	×	9.5 ×	6.35 ×	30.0 ×	×	20.0 ×	90.0
5	5	70.0 ×	×	×	6.35 ×	35.0 ×	×	20.0 ×	100.0
6	6	70.0 ×	×	×	27.8 ×	30.0 ×	×	20.0 ×	90.0
7	7	38.0 ×	×	15.0 ×	15.1 ×	38.0 ×	×	20.0 ×	86.0
8	8	38.0 ×	×	9.5 ×	25.4 ×	38.0 ×	×	20.0 ×	86.0
9	9	38.0 ×	×	9.5 ×	12.7 ×	38.0 ×	×	20.0 ×	86.0
10	10	86.0 ×	15° ×	×	×	13.0 ×	7.9 ×	20.0 ×	86.0
11	11-A	86.0 ×	×	19.0 ×	×	20.0 ×	7.9 ×	20.0 ×	90.0
12	11-B	86.0 ×	×	22.0 ×	×	20.0 ×	9.5 ×	20.0 ×	90.0
13	13	86.0 ×	×	14.0 ×	×	13.0 ×	×	20.0 ×	86.0

※other specifications are available upon request.

▶ Standard Profiles

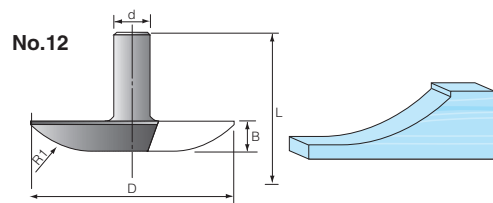
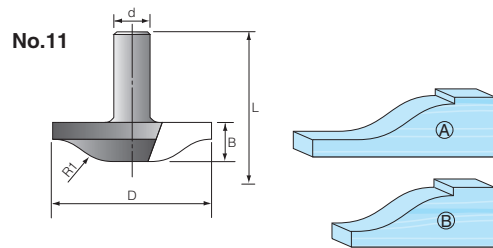
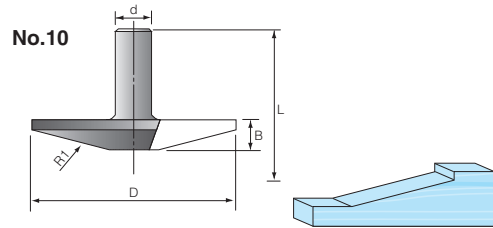
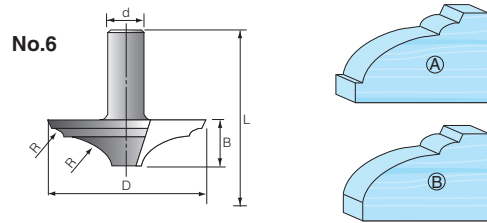
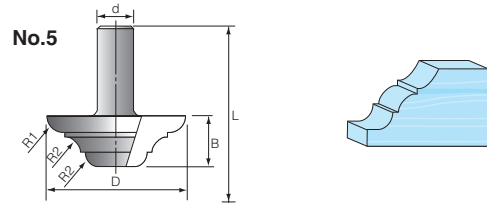
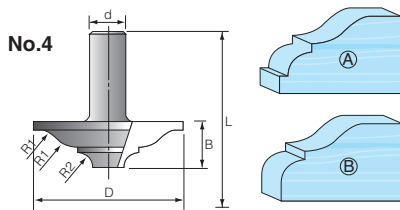
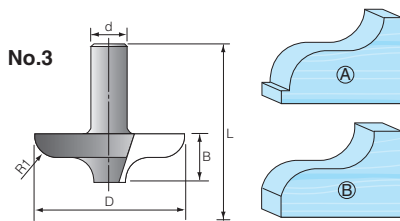
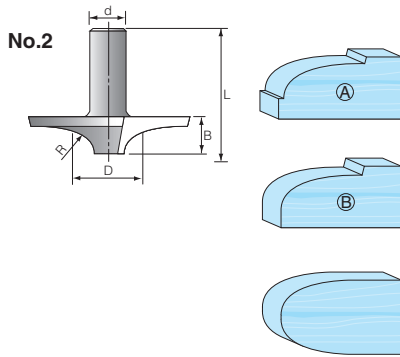
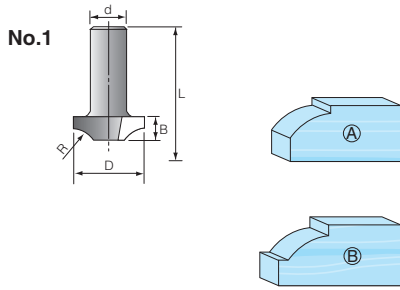

► Standard Profiles

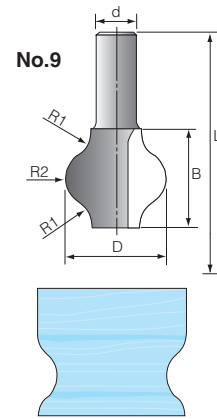
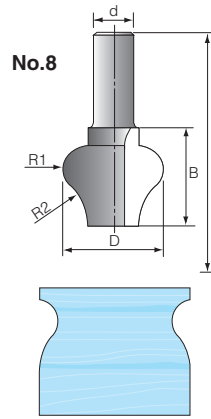
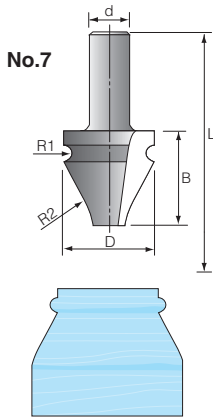

12 different handrail patterns

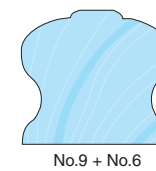
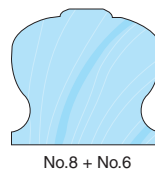
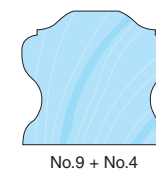
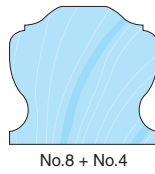
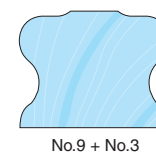
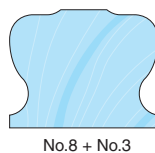
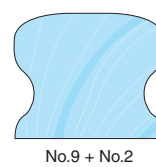
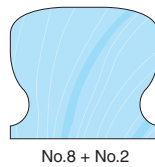
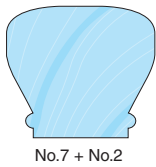

Acryl-Bit

Mirror Finish Router Bit

APPLICATION

Routing

MACHINE

CNC router machine

MATERIAL

PMMA

EDGE MATERIAL

HW

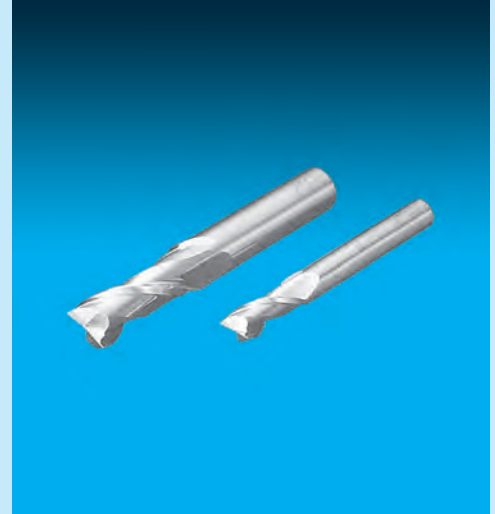

► Features & Benefits

- Absolute transparent cut finish reduces subsequent polishing
- Best performance with Hydro-Mechanical Precision Chuck

	Acryl-Bit (Type1)	Acryl-Bit (Type3)
Transparency	◎	○
Protection sheeted material	×	◎
Cutting life	○	○

EDGE MATERIAL
HW

► Acryl-Bit (Type1)

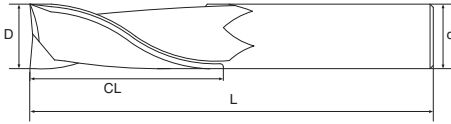

Order no.	Size					z	Type	Rotation
	d [mm]	D [mm]	L [mm]	CL [mm]				
1 827-0019-900	6	6	70	15	2	Spiral	R/Pos.	
2 827-0035-900	10	10	80	30	2	Spiral	R/Pos.	
3 827-0043-900	12	12	85	35	2	Spiral	R/Pos.	

► Acryl-Bit (Type3)

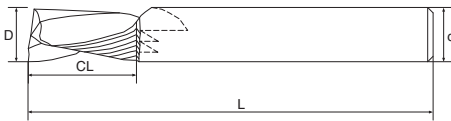

Order no.	Size					z	Type	Rotation
	d [mm]	D [mm]	L [mm]	CL [mm]				
1 827-3005-900	3	2	60	6	1+1	Pos.+Neg.	R/Pos.+Neg.	
2 827-3013-900	4	4	60	10	1+1	Pos.+Neg.	R/Pos.+Neg.	
3 827-3021-900	6	6	70	15	1+1	Pos.+Neg.	R/Pos.+Neg.	
4 827-3039-900	10	10	80	20	1+1	Pos.+Neg.	R/Pos.+Neg.	
5 827-3047-900	12	12	85	30	1+1	Pos.+Neg.	R/Pos.+Neg.	

Cosmo-Bit

PCD tipped Router Bit

APPLICATION

Routing, grooving and rabbeting

MACHINE

CNC router machine

MATERIAL

Core : MDF, particleboard
Lamination : Paper, melamine, HPL
Else : Various plastics, mineral boards

EDGE MATERIAL

DP

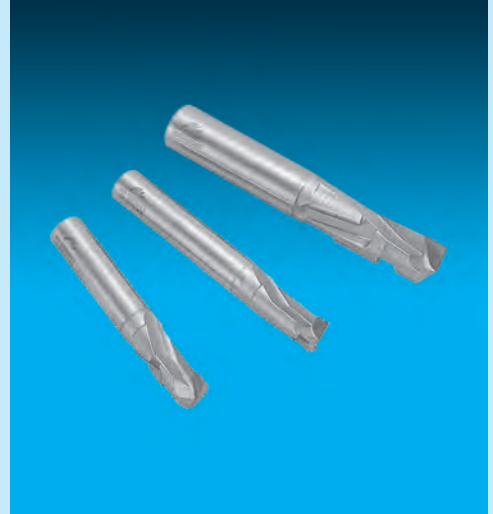

Features & Benefits

- Positive and negative shear angle for tear out free edges on both sides of the material
- Regrinding allowance is 1mm
- Best performance with a Hydro-Mechanical Precision Chuck

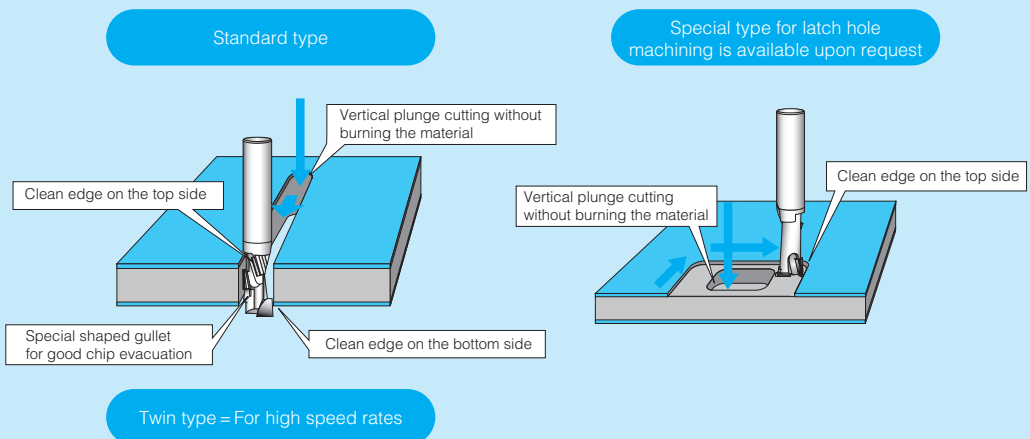

EDGE MATERIAL
DP

▶ Cosmo-Bit (Standard Type)

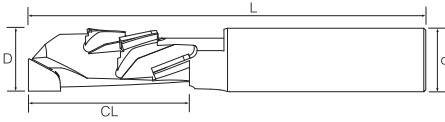

Order no.	d [mm]	D [mm]	Size L [mm]	CL [mm]	z	Rotation
1 890-0000-350	12	12	70	10	1+1	R
2 890-0000-350	12	12	75	15	1+2	R
3 890-1268-350	12	12	85	25	1+4	R
4 890-0000-350	16	16	70	11.4	1+2	R
5 890-0000-350	16	16	75	16	1+2	R
6 890-1648-350	16	16	80	21.5	1+3	R
7 890-A764-350	16	16	85	27	1+4	R
8 890-1705-350	16	16	95	32.5	1+5	R
9 890-0000-350	16	16	100	38	1+6	R
10 890-1755-350	16	16	100	40	1+6	R
11 890-A765-350	20	20	70	12	1+1	R
12 890-A766-350	20	20	80	19	1+2	R
13 890-0000-350	20	20	85	26	1+3	R
14 890-2068-350	20	20	95	33	1+4	R

▶ Cosmo-Bit (Special Type)

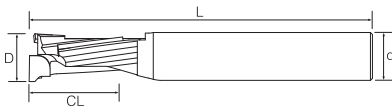

Order no.	d [mm]	D [mm]	Size L [mm]	CL [mm]	z	Rotation
1 890-0624-350	12	12	75	25	1+3	R
2 890-1177-350	12	12	85	22	1+2	R
3 890-0674-350	16	16	100	40	1+5	R
4 890-1002-350	20	20	100	40	1+5	R

EDGE MATERIAL
DP

▶ Cosmo-Bit (TWIN Type)

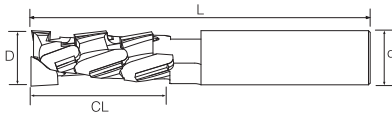

Order no.	d [mm]	D [mm]	Size L [mm]	CL [mm]	z	Rotation
1 890-0000-350	16	16	85	26	2+2	R
2 890-0038-350	16	16	100	40	2+2	R
3 890-0000-350	16	18	85	26	2+2	R
4 890-0000-350	16	18	100	40	2+2	R
5 890-0088-350	20	20	85	26	2+2	R
6 890-0096-350	20	20	100	40	2+2	R
7 890-0000-350	20	22	85	23	2+2	R
8 890-0000-350	20	22	100	40	2+2	R

▶ Cosmo-Bit "ZERO" (Single Use Type)

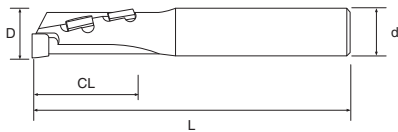

Order no.	d [mm]	D [mm]	Size L [mm]	CL [mm]	z	Rotation
1 890-3008-350	12	12	75	25	1+1	R
2 890-3016-350	12	12	75	25	1+1	R
3 890-3024-350	16	16	100	40	1+1	R

▶ Cosmo-Bit "NEST" (High speed Type)

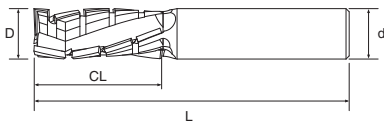

Order no.	d [mm]	D [mm]	Size L [mm]	CL [mm]	z	Rotation
1 890-1804-350	12	12	85	30	3	R
2 890-1812-350	12	12	85	30	3	R (Heavy routing)
3 890-1820-350	16	16	100	40	3	R
4 890-1838-350	16	16	100	40	3	R (Heavy routing)

6

Carpentry

KANFU S A

Brad Point Drill Bit	117
ACE Counterbore Drill Bit	118
Pre Cut Tooling	119



Carpentry

Brad Point Drill Bit

APPLICATION

Truss, beam manufacturing

MACHINE

Joinery machines such as Nakajima, Heian, Miyagawa, Hundegger

MATERIAL

Softwoods, hardwoods

EDGE MATERIAL

HW

PAT.EP0805006, US5897274

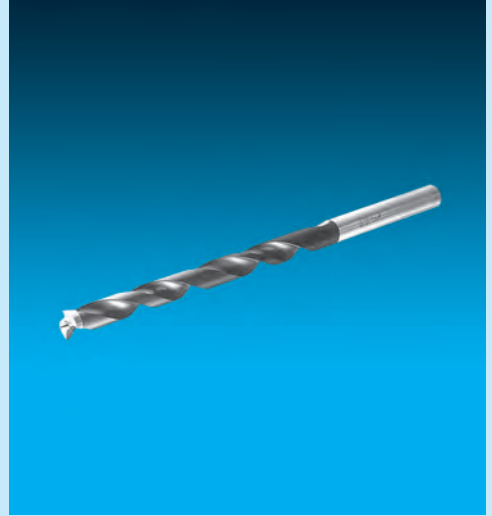

Features & Benefits

- Hardened body withstands bending even under heaviest loads
- Coated flutes lead to an excellent chip evacuation

Available Sizes : D = 12 mm – 30 mm
L ≤ 380 mm

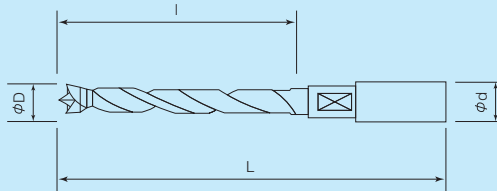

ACE Counterbore Drill Bit

With Brad Point Drill Bit

APPLICATION

Truss, beam manufacturing

MACHINE

Joinery machines such as Nakajima, Heian, Miyagawa, Hundegger

MATERIAL

Softwoods, hardwoods

EDGE MATERIAL

HW



PAT.EP0805006, US5897274

Features & Benefits

- Hardened body withstands bending even under heaviest loads
- Due to a special cutting edge design, it cuts wood fibers clean and tear out free

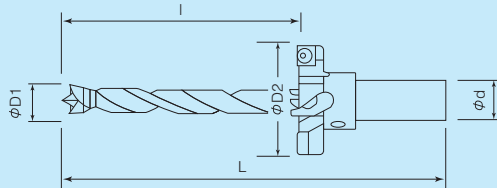

D1	D2	L	d	l	Machine
[mm]	[mm]	[mm]	[mm]	[mm]	
15	60	215	20	133	SHODA
15	60	224	16	154	MIYAGAWA
15	60	234	16	176	MIYAGAWA
15	65	235	16	150	NAKAJIMA
15	60	280	16	200	MARUNAKA
15	65	250	16	165	NAKAJIMA
16	60	260	20	163	HEIAN
18	60	279	18	177	SINX
18	60	290	20	208	KIKUKAWA

Other sizes are available upon request

Pre Cut Tooling

APPLICATION

Truss and beam manufacturing

MACHINE

Joinery machines such as Hundegger, Nakajima, Heian, Miyagawa

MATERIAL

Softwoods, hardwoods

EDGE MATERIAL

HS / HW / HC-UP



※HC-UP coating requires a special resharpening method

► Features & Benefits

- We manufacture a wide range of cutter and router and chisel mortiser used in truss and beam manufacturing
- For further information please contact Kanefusa



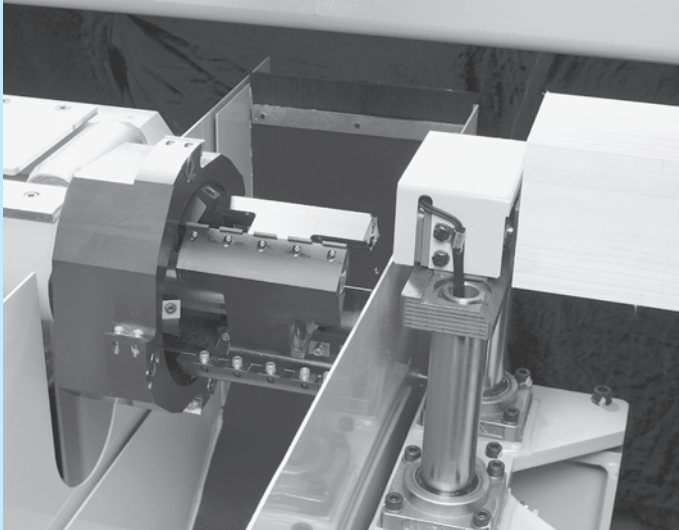

7

Accessories

Hydraulic Precision Chuck <i>CNC-Router Machine</i>	123
Hydro Mechanical Precision Chuck <i>CNC-Router Machine</i>	123
Hydro Tool Holder <i>Powermat</i>	125
Tool Holder <i>Powermat</i>	125
Hydro Sleeve	127
Locking Ring <i>Safety Part</i>	127



High Precision Chucks

CNC-Router machines

APPLICATION

High precision tool holder for shank type tooling

MACHINE

CNC router machines

The maximum allowable speed is 25000 RPM. Both holder can be used for right hand and left hand rotation. Both types are available for shaft type: HSK 63F, SK30, SK40, BT30, BT40, SCM 30, CMS30

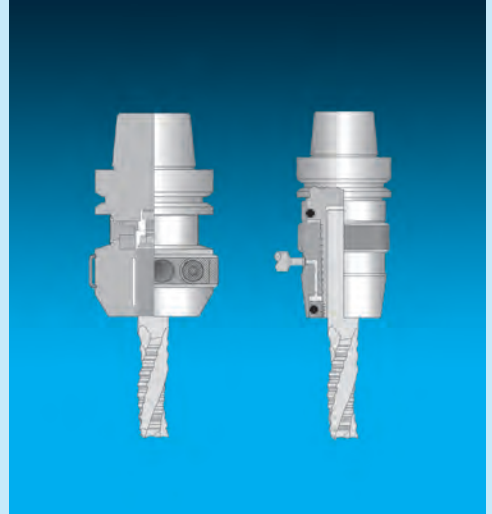

► Features & Benefits

Type 1 Hydraulic Precision Chuck

The hydraulic clamping system is user friendly. Tightening up or loosening the pressure screw activates and deactivates it. The tool shank must have a length adjustment screw

Type 2 Hydro-Mechanical Precision Chuck

The chuck holds the tool mechanically. This means there is no hydraulic influence when running the router. An external oil pump is used for clamping and releasing. The chuck transmits very high torques and enables high feeding rates. It is the perfect partner for the E-Bit, Acryl-Bit, Cosmo-Bit or SF-Profile Router Bits. In comparison to shrink fit and power fit holder, the advantages are :

- Tolerance grade 7 is accepted, compared to grade 6 for shrink fit holders
- Changing the tool will take about 20 sec. compared to several minutes
- The equipment is less expensive and easier to handle
- It gives you the possibility to adjust the tool, in z-direction, exactly since you have at least one hand free when clamping
- No limitations to the outer tool diameter or to the material of the shank

▶ Type1 Hydraulic Precision Chuck

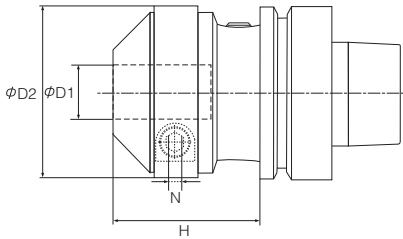

Order no.	Size			
	D1 [mm]	D2 [mm]	H [mm]	N [mm]
1	12	55	42.5	6
2	16	58	48	6
3	20	63	54	6
4	25	67	61.5	6
5	1/2"	55	42.5	6
6	5/8"	58	48	6
7	3/4"	63	52.5	6
8	1"	67	61.5	6

▶ Type2 Hydraulic Precision Chuck

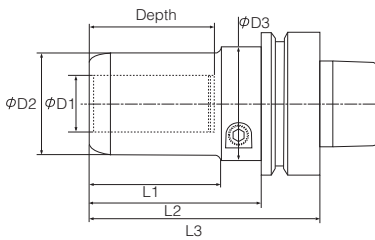

Order no.	Size					
	D1 [mm]	D2 [mm]	D3 [mm]	L1 [mm]	L2 [mm]	L3 [mm]
1	12	32	40	43	61	87
2	16	38	40	43	61	87
3	20	40	50	55	73	99
4	25	45	50	59	77	103
5	1/2"	32	40	43	61	87
6	5/8"	38	40	43	61	87
7	3/4"	40	50	55	73	99
8	1"	45	50	59	77	103

▶ Type3 Hydro-Mechanical Precision Chuck

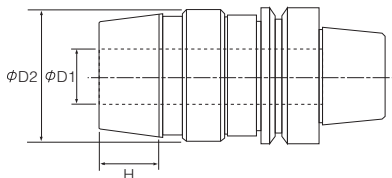

Order no.	Size		
	D1 [mm]	D2 [mm]	H [mm]
1	12	34	8
2	16	41.5	8.5
3	20	53	10.5
4	25	62.5	12
5	1/2"	34	8
6	5/8"	41.5	8.5
7	3/4"	53	10.5
8	1"	62.5	12

Hydro Tool Holder

Powermat

APPLICATION

For use of bore-type tooling on Powermat moulders

MACHINE

Powermat



► Features & Benefits

- In order to use bore type tooling on Powermat machines the cutter must be clamped on an arbor with HSK taper
- Hydro arbors reduce the play between the cutter and the arbor enabling a better cut finish and longer tool life
- Can be shared with other tools



Regular tool holder without hydro clamping are available.

▶ Hydro Tool Holder Short

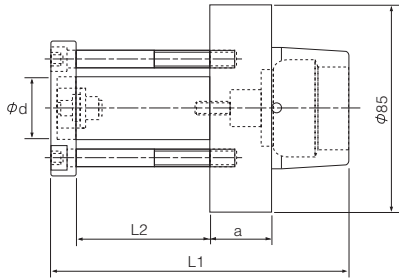

Order no.	Size				
	D [mm]	d [mm]	L2 [mm]	L1 [mm]	a [mm]
1	85	30	40	108	26
2	85	30	55	123	26
3	85	30	100	168	26
4	85	40	55	123	26

▶ Hydro Tool Holder Long

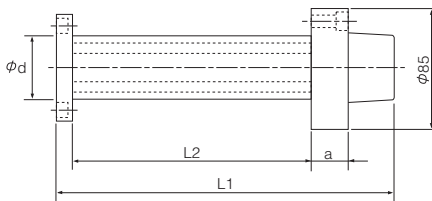

Order no.	Size				
	D [mm]	d [mm]	L2 [mm]	L1 [mm]	a [mm]
1	85	40	170	238	26
2	85	40	240	308	26
3	85	50	210	278	26

▶ Tool Holder

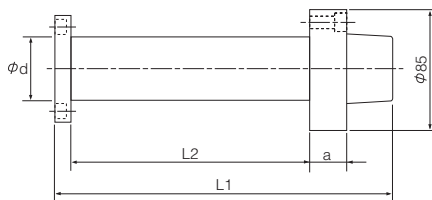

Order no.	Size				
	D [mm]	d [mm]	L2 [mm]	L1 [mm]	a [mm]
1	85	30	25	50	26
2	85	30	50	75	26
3	85	30	75	100	26
4	85	40	130	155	26
5	85	40	170	195	26
6	85	40	240	265	26

Hydro Sleeve

APPLICATION

Reduces play between spindle and arbor

MACHINE

Moulder, tenoner, finger joint machines

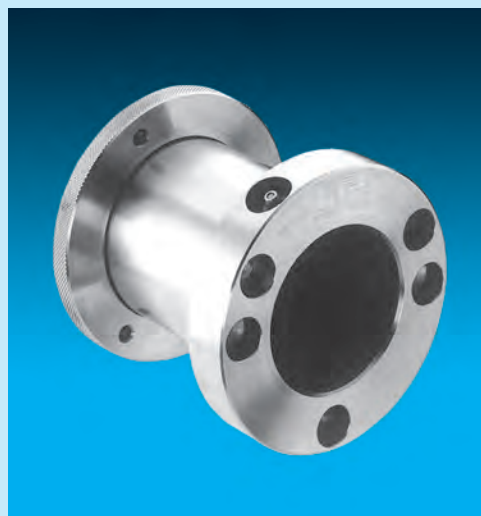

Features & Benefits

- Hydraulic sleeves reduce the play between the cutter and the machine arbor and enable concentric running of the tool. A good run-out leads to a better cut finish and longer edge life
- The hydraulic sleeve Types B and BI are provided with a threaded knurled ring nut and are easily exchangeable between tools
- Type A and B are pressurized with a grease pump
- Type AI and BI are closed systems and pressurized by tightening a pressure screw with a T-wrench

Locking Ring

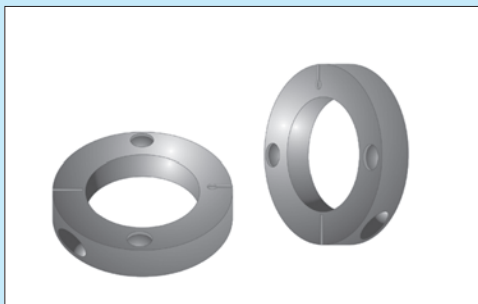

On open-ended spindles like on horizontal finger joint machines, it is essential to fit safety locknut or a well-secured safety ring to the spindle end.

Spindle Diameter
1 1/4"
1 13/16"
2 1/8"
2 3/16"
60 mm

► Hydro Sleeve Type A - Pressurized with a grease pump

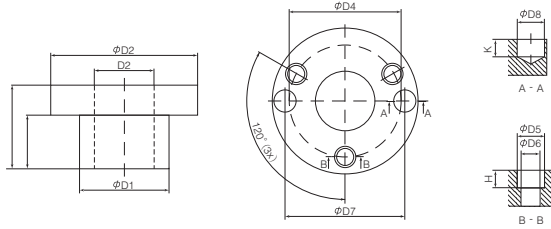

Order no.	Type	Size												
		D [mm]	D1 [mm]	D2 [mm]	D4 [mm]	D5 [mm]	D6 [mm]	D7 [mm]	D8 [mm]	H [mm]	K [mm]	L [mm]	L1 [mm]	Weight [kg]
1	A-1	30	40	83	64	10	6.0	65	15	5.5	10	55	35	0.8
2	A-2	30	50	83	64	10	6.0	65	15	5.5	10	55	35	1.0
3	A-3	35	50	83	64	10	6.0	65	15	5.5	10	55	35	0.9
4	A-4	40	50	83	64	10	6.0	65	15	5.5	10	55	35	0.8
5	A-5	35	60	93	74	14	10.5	75	15	8.5	10	55	35	1.3
6	A-6	40	60	93	74	14	10.5	75	15	8.5	10	55	35	1.2
7	A-7	45	60	93	74	14	10.5	70		8.5		55	35	1.1
8	A-8	50	60	93	74	14	10.5	75	15	8.5	10	55	35	0.9
9	A-9	40	60	93	74	14	10.5	75	15	8.5	10	75	55	1.5
10	A-10	45	60	93	74	14	10.5	75		8.5		75	55	1.3
11	A-11	50	60	93	74	14	10.5	75		8.5	10	75	55	1.1
		[inch]												
12	A-12	1 1/4"	40	75	55	15	10.5	55	15	9	10	55	35	0.7
13	A-13	1 13/16"	60	93	74	15	10.5	75	15	8.5	10	55	35	1.1
14	A-14	1 13/16"	65	98	80	15	10.5	80	15	9	10	55	35	1.4
15	A-15	2 1/8"	65	98	80	15	10.5	80	15	9	10	55	35	1.1

► Hydro Sleeve Type AI (Closed system) - Pressurized with a T-wrench

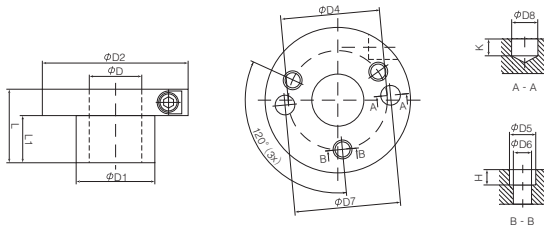

Order no.	Type	Size												Weight [kg]
		D [mm]	D1 [mm]	D2 [mm]	D4 [mm]	D5 [mm]	D6 [mm]	D7 [mm]	D8 [mm]	H [mm]	K [mm]	L [mm]	L1 [mm]	
1	AI-1	30	40	80	55	15	8.5	55	9	8.5	10	55	35	1.0
2	AI-2	30	50	83	64	10	6	65	15	5.5	10	55	35	1.2
3	AI-3	35	50	83	64	10	6	65	15	5.5	10	55	35	1.1
4	AI-4	40	50	83	64	10	6	65	15	5.5	10	55	35	1.1
5	AI-5	35	60	93	74	14	10.5	75	15	8.5	10	55	35	1.4
6	AI-6	40	60	93	74	15	10.5	75	15	8.5	10	55	35	1.3
7	AI-7	45	60	93	74	15	10.5	70		8.5		55	35	1.2
8	AI-8	50	60	93	74	14	10.5	75	15	8.5	10	55	35	1.0
9	AI-9	50	65	98	80	15	10.5	80	15	8.5	10	55	35	1.3
10	AI-10	40	60	93	74	15	10.5	75	15	8.5	10	75	55	1.7
11	AI-11	45	60	93	74	15	10.5	70		8.5		75	55	1.5
12	AI-12	50	60	93	74	14	10.5	75	15	8.5	10	75	55	1.2
		[inch]												
13	AI-13	1 1/4"	40	83	55	15	10.5	55	15	9	10	55	35	1.0
14	AI-14	1 1/2"	50	93	64	15	10.5	65	15	8.5	10	55	35	1.1
15	AI-15	1 13/16"	60	93	74	15	10.5	75	15	8.5	10	55	35	1.2
16	AI-16	1 13/16"	65	98	80	15	10.5	80	15	8.5	10	55	35	1.5
17	AI-17	2 1/8"	65	98	80	15	10.5	80	15	8.5	10	55	35	1.3

► Hydro Sleeve Type B - Pressurized with a grease pump

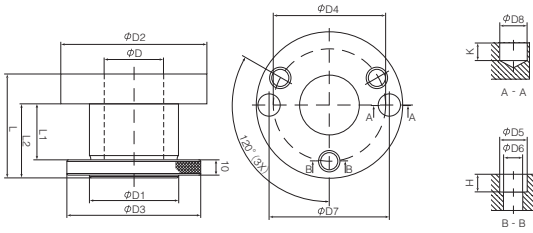

Order no.	Type	Size														Weight [kg]
		D [mm]	D1 [mm]	D2 [mm]	D3 [mm]	D4 [mm]	D5 [mm]	D6 [mm]	D7 [mm]	D8 [mm]	H [mm]	K [mm]	L [mm]	L1 [mm]	L2 [mm]	
1	B-1	30	50	83	83	64	10	6.0	65	15	5.5	10	75	40	55	1.5
2	B-2	35	50	83	83	64	10	6.0	65	15	5.5	10	75	40	55	1.4
3	B-3	35	50	83	83	64	10	6.0	65	15	5.5	10	115	80	95	1.6
4	B-4	35	50	83	83	64	10	6.0	65	15	5.5	10	165	130	145	2.0
5	B-5	35	60	93	90	74	14	10.5	75	15	8.5	10	75	40	55	1.9
6	B-6	35	60	93	90	74	14	10.5	75	15	8.5	10	115	80	95	2.5
7	B-7	35	60	93	90	74	14	10.5	75	15	8.5	10	140	105	120	2.8
8	B-8	35	60	93	90	74	14	10.5	75	15	8.5	10	165	130	145	3.0
9	B-9	40	50	83	83	64	10	6.0	65	15	5.5	10	75	40	55	1.2
10	B-10	40	50	83	83	64	10	6.0	65	15	5.5	10	115	80	95	1.3
11	B-11	40	50	83	83	64	10	6.0	65	15	5.5	10	140	105	120	1.5
12	B-12	40	50	83	83	64	10	6.0	65	15	5.5	10	165	130	145	1.6
13	B-13	40	50	83	83	64	10	6.0	65	15	5.5	10	190	155	170	1.7
14	B-14	40	60	93	90	74	15	10.5	75	15	8.5	10	75	40	55	1.7
15	B-15	40	60	93	90	74	15	10.5	75	15	8.5	10	95	60	75	2.0
16	B-16	40	60	93	90	74	15	10.5	75	15	8.5	10	115	80	95	2.2
17	B-17	40	60	93	90	74	15	10.5	75	15	8.5	10	140	105	120	2.5
18	B-18	40	60	93	90	74	15	10.5	75	15	8.5	10	165	130	145	2.8
19	B-19	40	60	93	90	74	15	10.5	75	15	8.5	10	215	180	195	3.4
20	B-20	45	60	93	90	74	15	10.5	70		8.5		75	40	55	1.5
21	B-21	45	60	93	90	74	15	10.5	70		8.5		95	60	75	1.7
22	B-22	45	60	93	90	74	15	10.5	70		8.5		115	80	95	1.9
23	B-23	45	60	93	90	74	15	10.5	70		8.5		140	105	120	2.1
24	B-24	45	60	93	90	74	15	10.5	70		8.5		190	155	170	2.6
25	B-25	45	60	93	90	74	15	10.5	70		8.5		240	205	220	3.1

► Hydro Sleeve Type B - Pressurized with a grease pump

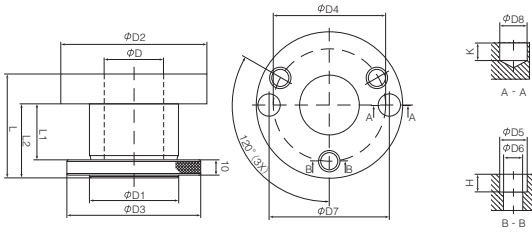

Order no.	Type	Size														
		D [mm]	D1 [mm]	D2 [mm]	D3 [mm]	D4 [mm]	D5 [mm]	D6 [mm]	D7 [mm]	D8 [mm]	H [mm]	K [mm]	L [mm]	L1 [mm]	L2 [mm]	Weight [kg]
26	B-26	50	60	93	90	74	15	10.5	75	15	8.5	10	75	40	55	1.3
27	B-27	50	60	93	90	74	15	10.5	75	15	8.5	10	95	60	75	1.4
28	B-28	50	60	93	90	74	15	10.5	75	15	8.5	10	115	80	95	1.6
29	B-29	50	60	93	90	74	15	10.5	75	15	8.5	10	140	105	120	1.7
30	B-30	50	60	93	90	74	15	10.5	75	15	8.5	10	190	155	170	2.1
31	B-31	50	60	93	90	74	15	10.5	75	15	8.5	10	230	195	210	2.4
32	B-32	50	60	93	90	74	15	10.5	75	15	8.5	10	240	205	220	2.5
		[inch]														
33	B-33	1 1/4"	40	75	75	55	15	10.5	55	15	9	10	85	50	65	1.1
34	B-34	1 1/4"	40	75	75	55	15	10.5	55	15	9	10	135	100	115	1.2
35	B-35	1 1/2"	50	83	83	64	15	10.5	64	15	9	10	85	50	65	1.2
36	B-36	1 1/2"	50	83	83	64	15	10.5	64	15	9	10	135	100	115	1.6
37	B-37	1 1/2"	50	83	83	64	15	10.5	64	15	9	10	185	150	165	2.0
38	B-38	1 13/16"	60	93	90	74	15	10.5	75	15	8.5	10	75	40	55	1.5
39	B-39	1 13/16"	60	93	90	74	15	10.5	75	15	8.5	10	115	80	95	1.8
40	B-40	1 13/16"	60	93	90	74	15	10.5	75	15	8.5	10	140	105	120	2.0
41	B-41	1 13/16"	60	93	90	74	15	10.5	75	15	8.5	10	190	155	170	2.5
42	B-42	1 13/16"	65	98	98	80	15	10.5	80	15	9	10	85	50	65	2.1
43	B-43	1 13/16"	65	98	98	80	15	10.5	80	15	9	10	135	100	115	2.7
44	B-44	1 13/16"	65	98	98	80	15	10.5	80	15	9	10	185	150	165	3.4
45	B-45	1 13/16"	65	98	98	80	15	10.5	80	15	9	10	235	200	215	4.0
46	B-46	2 1/8"	65	98	98	80	15	10.5	80	15	9	10	85	50	65	1.7
47	B-47	2 1/8"	65	98	98	80	15	10.5	80	15	9	10	135	100	115	2.1
48	B-48	2 1/8"	65	98	98	80	15	10.5	80	15	9	10	185	150	165	2.5
49	B-49	2 1/8"	65	98	98	80	15	10.5	80	15	9	10	235	200	215	2.9
50	B-50	2 1/8"	65	98	98	80	15	10.5	80	15	9	10	285	250	265	3.3

► Hydro Sleeve Type BI (Closed system) - Pressurized with a T-wrench

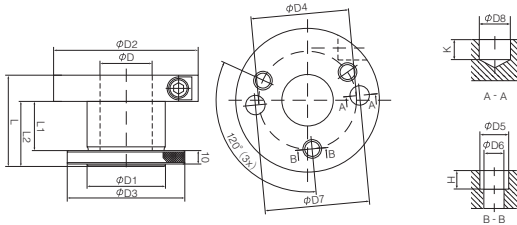

Order no.	Type	Size														Weight [kg]
		D [mm]	D1 [mm]	D2 [mm]	D3 [mm]	D4 [mm]	D5 [mm]	D6 [mm]	D7 [mm]	D8 [mm]	H [mm]	K [mm]	L [mm]	L1 [mm]	L2 [mm]	
1	BI-1	35	50	100	83	64	15	10.5	65	15	8.5	10	75	40	55	1.5
2	BI-2	35	60	102	90	74	15	10.5	75	15	8.5	10	75	40	55	2.1
3	BI-3	40	50	100	83	64	15	10.5	65	15	8.5	10	75	40	55	1.3
4	BI-4	40	60	102	90	74	15	10.5	75	15	8.5	10	75	40	55	1.9
5	BI-5	40	60	108	90	74	15	10.5	75	15	8.5	10	95	60	75	2.1
6	BI-6	40	60	108	90	74	15	10.5	75	15	8.5	10	115	80	95	2.4
7	BI-7	40	60	114	90	74	15	10.5	75	15	8.5	10	140	100	115	3.3
8	BI-8	45	60	102	90	74	15	10.5	70		8.5		75	40	55	1.7
9	BI-9	45	60	108	90	74	15	10.5	70		8.5		95	60	75	1.9
10	BI-10	45	60	108	90	74	15	10.5	70		8.5		115	80	95	2.1
11	BI-11	45	60	114	90	74	15	10.5	75		8.5		140	100	115	2.9
12	BI-12	50	60	102	90	74	15	10.5	75	15	8.5	10	75	40	55	1.5
13	BI-13	50	60	108	90	74	15	10.5	75	15	8.5	10	95	60	75	1.6
14	BI-14	50	60	108	90	74	15	10.5	75	15	8.5	10	115	80	95	1.8
15	BI-15	50	60	114	90	74	14	10.5	75	15	8.5	10	140	100	115	2.5
		[inch]														
16	BI-16	1 1/2"	50	100	83	64	15	10.5	65	15	8.5	10	85	50	65	1.7
17	BI-17	1 1/2"	50	106	83	64	15	10.5	65	15	8.5	10	135	100	115	1.8
18	BI-18	1 13/16"	60	102	90	74	15	10.5	75	15	8.5	10	75	40	55	1.7
19	BI-19	1 13/16"	60	108	90	74	15	10.5	75	15	8.5	10	95	60	75	1.9
20	BI-20	1 13/16"	60	108	90	74	15	10.5	75	15	8.5	10	115	80	95	2.1
21	BI-21	1 13/16"	60	114	90	74	15	10.5	75	15	8.5	10	140	100	115	2.8
22	BI-22	1 13/16"	65	108	98	80	15	10.5	80	15	9	10	85	50	65	2.3
23	BI-23	1 13/16"	65	117	98	80	15	10.5	80	15	8.5	10	135	95	110	3.5
24	BI-24	2 1/8"	65	108	98	80	15	10.5	80	15	9	10	85	50	65	1.9
25	BI-25	2 1/8"	65	117	98	80	15	10.5	80	15	8.5	10	135	95	110	2.8

8

Industrial Knives

Plywood Knife <i>Veneer Knife</i>	135
Clipper Knife <i>Veneer Knife</i>	135
Timber Tec <i>Chipper Knife</i>	136
Flaker Knife <i>Chipboard & OSB Production</i>	137

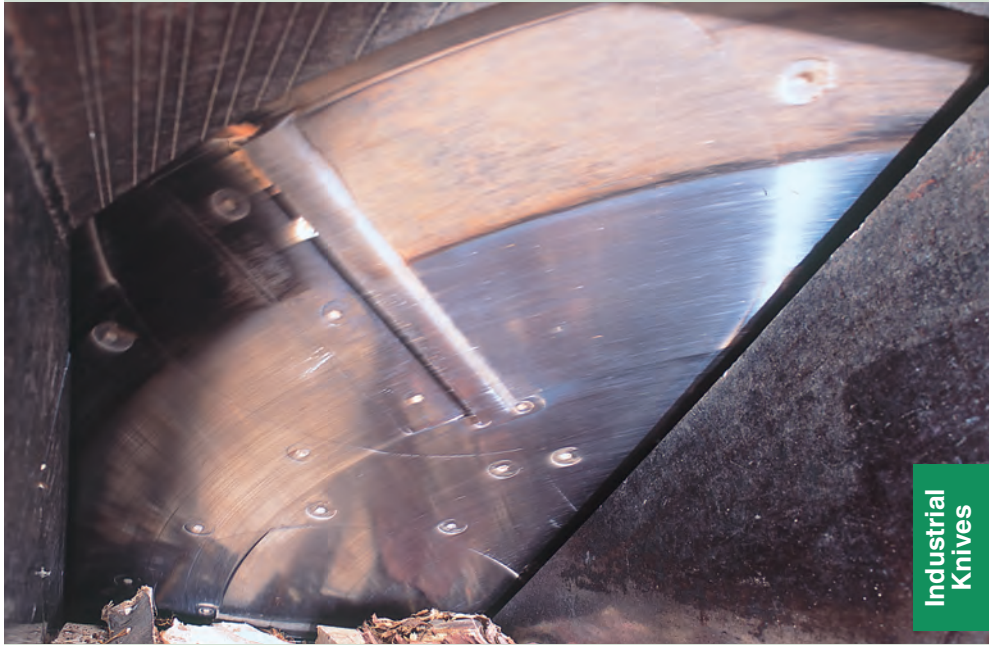

Veneer Knives

APPLICATION

Peeling, slicing and clipping of veneer

MACHINE

Rotary lathe, horizontal slicer machine, vertical slicer machine, clipper

MATERIAL

Softwoods, hardwoods, tropical woods

EDGE MATERIAL

Alloy Steel (solid)
High Alloy Steel (inlaid and solid)
Semi-High Speed Steel (inlaid)
High Speed Steel (inlaid)

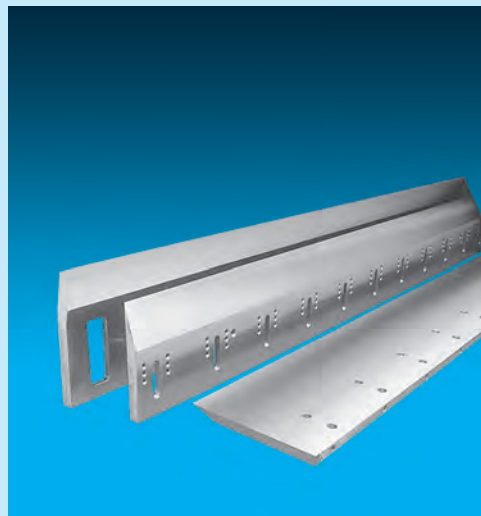

Features & Benefits

- We have perfected the manufacturing of veneer knives. Extreme flatness, parallelism and edge holding ability provide hours of continuous veneer cutting for tight thickness requirements
- Provides maximum chipping and wear resistant properties
- The knives are manufactured per drawing or according to a sample

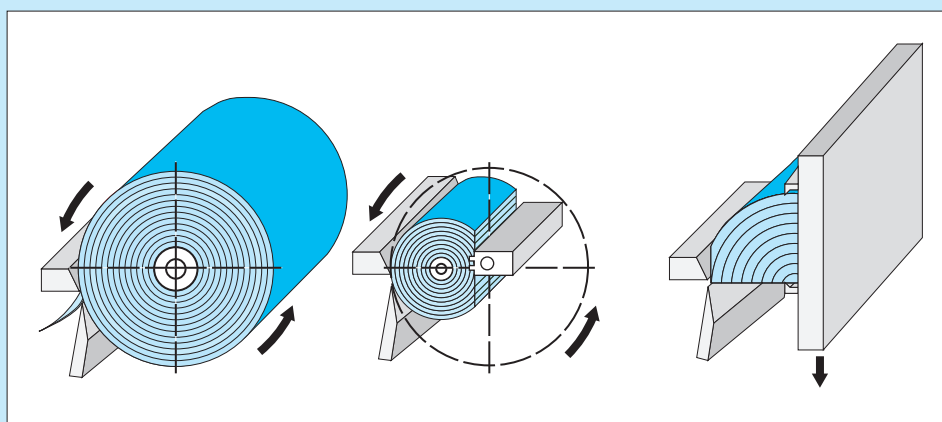

Timber Tec

Chipper Knife

MACHINE

Chipper machine

MATERIAL

Softwoods, hardwoods

EDGE MATERIAL

Special Alloy Steel (solid)



► Features & Benefits

- Timber Tec Chipper Knives are made from a new grade special alloy steel. Thanks to its hardness, it outlasts conventional knives by more than 2 times
- The knife angle may vary between 26° and 40° according to machine and condition of the timber
- Besides knives, we also deliver counter-knives, pressure bars, and lapping stones other accessories made from die steel and alloy steel
- Chipper knives in Tool Steel (solid), High Alloy Steel (solid) and Semi-HSS (inlay) are available
- The knives are manufactured per drawing or according to a sample

Efficiency Study at a User in South East Asia

	Timber Tec Chipper Knife		Conventional Chipper Knife	
	Run time [h]	Chip production [t]	Run time [h]	Chip production [t]
1	1 : 14	378.55	0 : 46	179.45
2	1 : 58	445.18	0 : 38	116.79
3	1 : 57	469.64	0 : 44	152.95
4	2 : 05	583.05	0 : 42	144.05
5	1 : 51	538.54	0 : 47	171.38
6	0 : 54	251.87	0 : 36	136.88
7	2 : 46	657.33	0 : 52	196.07
⊙	1 : 49	474.88	0 : 43	156.80

Machine : Metso Paper
Model : Camura GS
Material : Mixed hardwood

Flaker Knives

APPLICATION

Chipping of timber for use in
OSB or particleboard production

MACHINE

Ring and drum flaker such as Pallmann, Maier

MATERIAL

Softwoods, hardwoods

EDGE MATERIAL

Tool steel (solid)
Special Alloy Steel (solid)

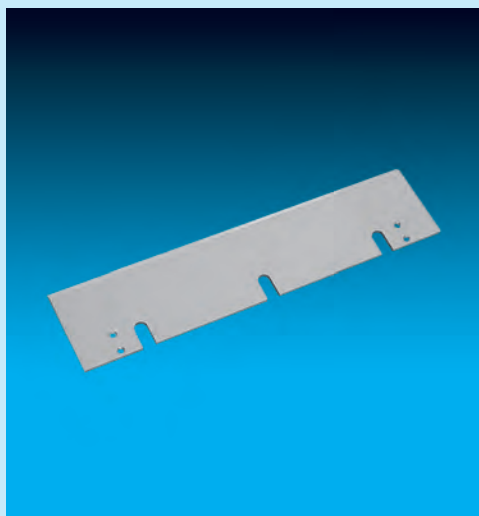

Features & Benefits

- Besides knives, we also supply consumable parts of ring flakers such as wear shoes, knife holder plates, guide shoes, etc
- The knives are manufactured according to a drawing or a sample

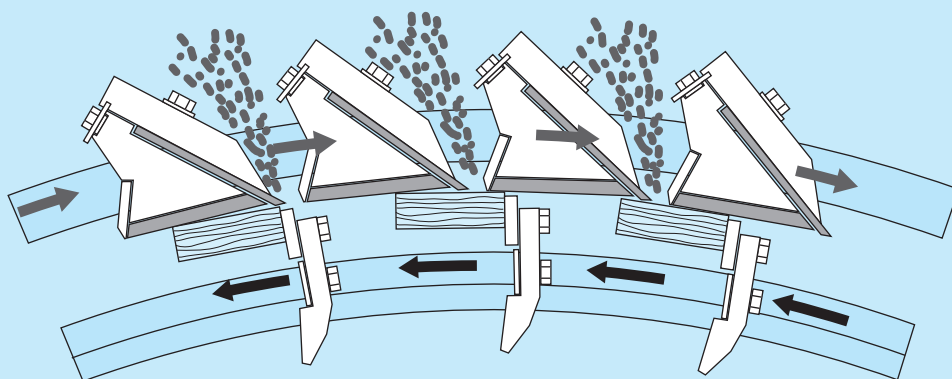

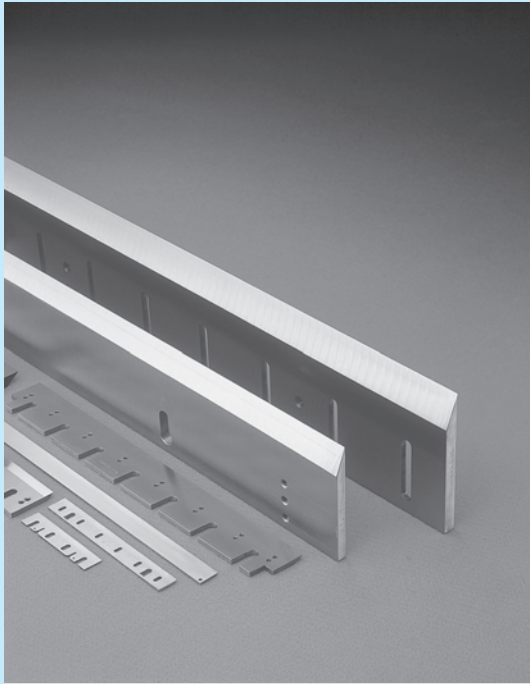

Company Profile

Business Activities	141
Global Network	143
Quality	145
History	147



Business Activities

Cutting tool is an essential part in the manufacturing process of almost any product in any industry all around the world. Productivity, product quality, quality rates and the effective use of resources depend on the quality of the tools used.

Kanefusa develops, manufactures and supplies value-added tools and services to users in the woodworking, metalworking, plastic and paper industries.

Woodworking Industry



Metalworking Industry



Research & Development

In August 1995, the new Technical Center for enhanced research and development activities was completed. In order to carry out intense research activities in areas of material science, cutting and grinding technology, state of the art equipment such as scanning electron microscopes (SEM), experimental furnaces, CNC-router machines, moulder and various sawing machines are available to our dedicated engineers.

Activities

- Developing products with clear user value and testing of tooling in respect to performance, safety and function
- Joint research, development and experimentation with users and machine builders
- Research and development of cutting and grinding technologies
- Rapid prototyping

Manufacturing Techniques

Our motto is "quality products arrive from quality equipment and techniques". We have been proactively developing various manufacturing technologies. Parallel fulfillment of the detailed pursuit of quality and reduction of cost is our focus when developing equipment. Awareness of further improvements leads to in-house development of machines designed with the originality and ingenuity of our engineers. Approximately 40% of equipment used at our factory has been developed by our engineers. We are dedicated to supplying reliable tools and service by further development of equipment and manufacturing techniques aimed at improved quality, reduction of costs higher precision and better function.

Sales Activities

Knowledge, responsiveness and reliable customer support have become key drivers in today's business. It is therefore of utmost importance to transfer the technical know-how of our R&D Center as well as commercial information into our subsidiaries and distributor network. Besides providing appropriate literature and demonstration models, hands-on seminars have proven to be one of the most effective ways of enhancing the competence of our Distribution Network. We offer seminars and practical training courses for all knowledge levels, from the beginner to the professional.

On a regular basis we inform the consumer as well as our sales network through our website newsletter of the participation in trade shows and the organization of conferences about newly developed products and technologies, market news and intra-company information. Opinion and experience exchanges are vital parts in our development of new products, technologies and services.

Paper Industry



Plastic Industry & Special Projects



Global Network

Our world-spanning network guarantees local user satisfaction

P.T. KANEFUSA INDONESIA, and KANEFUSA CHINA CORPORATION are offshore manufacturing sites. To ensure highest product quality, raw materials and semi-finished products are supplied from Japan and processed on state of the art machinery from Japan and Germany.

KANEFUSA USA, INC., KANEFUSA EUROPE B.V., Malaysia Office, P.T. KANEFUSA INDONESIA and KUNSHAN KANEFUSA CORPORATION support our distributor network in commercial and technical issues and carry out grinding services (except KFE, Malaysia Office and KANEFUSA DO BRASIL LTDA.) in order to ensure highest user satisfaction and customer retention.



North America

■ **KANEFUSA USA, INC.**
 621 Dolwick Drive, Erlanger, KY 41018, USA
 TEL: +1 859 283 1450 FAX: +1 859 283 5256
 E-mail: sales@kanefusa-na.com

South America

■ **KANEFUSA DO BRASIL LTDA.**
 Rua Joaquim de Almeida, 75, Sao Paulo, SP, Brasil, CEP04050-010
 TEL: +55 11 2372 7664 FAX: +55 11 2372 7663
 E-mail: vendas@kanefusa.net.br

Europe

■ **KANEFUSA EUROPE B.V.**
 De Witbogt 12, 5652 AG, Eindhoven, The Netherlands
 TEL: +31 40 2900901 FAX: +31 40 2900908
 E-mail: info@kanefusa.nl

China

■ **KANEFUSA CHINA CORPORATION**
 NO.50 Zhuzhu Road, Lujia Town Kunshan city, Jiangsu, China
 TEL: +86 512 57875072 FAX: +86 512 57875073
 E-mail: yy@kanefusa-cn.com

■ **TIANJIN OFFICE**
 Sanjinglu No.5 Dongli economic development zone Tianjin city CHINA
 TEL: +86 22 5823 7633 FAX: +86 22 5823 7632
 E-mail: tjkfc03@kanefusa-cn.com

Southeast Asia

■ **PT. KANEFUSA INDONESIA**
 EJIP Industrial Park, Plot 8D, Cikarang Selatan, Bekasi 17550, West Java, Indonesia
 TEL: +62 21 897 0360 FAX: +62 21 897 0286 / 0287
 E-mail: sales@kanefusa.co.id

■ **Surabaya Service Center**
 Jl. Berbek Industri
 VII/5.B. Kepuhkiriman, Waru Sidoarjo 61256
 TEL: +62 31 8491784 FAX: +62 31 8492784

■ **KANEFUSA INDIA PRIVATE LIMITED**
 Plot No.232, Sector-8, IMT Manesar, Gurgaon, Haryana PIN 122-050 India
 TEL: +91 124 420 8440 FAX: +91 124 420 8441
 E-mail: info@kanefusa.co.in

■ **MALAYSIA OFFICE**
 Suite 839 Level 8, Pavilion KL 168 Jalan Bukit Bintang 55100 Kuala Lumpur, Malaysia
 TEL: +60 3 92057721 FAX: +60 3 92057720
 E-mail: kanefusamal@myjaring.net

Quality

Quality is when the customer comes back and not the product

Kanefusa is recognized throughout the world as a premium tool manufacturer and satisfied users testify to the reliability of our products and services.

It is also acknowledged by the market that we are continually striving to improve our company (Kaizen) and the quality of our processes, products and services. An essential factor in improving quality is the employee and the key words here are learning, knowledge and motivation. By way of regular seminars and training, our employees are updated with the latest machine, process, product, market and management knowledge enabling them to respond flexibly to the ever-changing market demands and ensuring the highest product and service quality.

Each department forms a Quality Improvement Team, which is part of the Kanefusa Quality Circle. The teams compete with each other, which keeps motivation high and ensures that the continuous improvement process does not stop. Occasionally, the teams compete with teams from other companies.



Technical Seminar



Kaizen Discussion



Quality Circle Team

Besides highly qualified and motivated employees, we are constantly investing in the latest machine and manufacturing equipment, computer systems and R&D equipment. If there is no technology available that satisfies our needs, we develop it. Our dedicated engineers develop about 40 % of our equipment.

Another part of our commitment to quality is to invent, produce and sell only products that are safe to use. One very important sales point of our products is that they run quieter, produce less dust, are easier to handle and have higher durability than other makes.

Naturally we are ISO 9001 and ISO 14001 certified.



Grinding Center

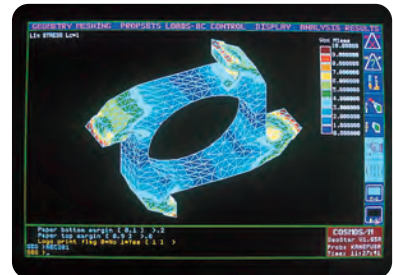

Tool Structure Analysis by FEM-technology



JQA-QM3710



JQA-EM3137

Head Office Factory

History

- 1896** The blacksmith Kankichi Kamiya establishes "Uchihamonoshi Kanefusa" (Forging Master of Agricultural Tools) in Goheizou, Nagoya.
- 1931** Suzuo Watanabe, son of the founder, succeeds the business of his father and makes extensive improvements to High Speed Steel machine knives.
- 1937** Kanefusa Hamono Ltd. is established.
- 1948** A new factory is built in Rokuban-cho, Atsuta-ku, Nagoya and the company is renamed Kanefusa Hamono Kogyo Co., Ltd.
- 1957** Suzuo Watanabe travels to Europe to research European knife manufacturing and steel refining technologies.
- 1959** Kanefusa is the first Japanese machine tool manufacturer to use a High Frequency Induction Heating System for mass production of quality knives.
- 1964** A new state of the art factory is built in Ohguchi-cho, Niwa-gun, Aichi Prefecture.
- 1965** The main factory in Ohguchi-cho receives JIS certification (JIS = Japan Industrial Standards).
- 1967** The first Research and Development Center is completed.
- 1968** For product distribution, Kanefusa Knife & Saw Co., Ltd. is established.
- 1969** Kanefusa receives the Contribution Award from the Minister of International Trade and Industry.
- 1970** The capacity of the heat treatment facility is largely increased.
- 1971** Suzuo Watanabe is inaugurated as chairman of the Japan Saw Blade & Knife Industrial Association (JSK). Kanefusa receives the Contribution Award from the Minister of International Trade and Industry for the second time.
- 1972** The production capacity of the T.C.T. saw blade plant is expanded.
- 1976** The Ministry of International Trade and Industry acknowledges Kanefusa Hamono Ltd. as a factory of superior industrial standard.
- 1981** Hiroshi Watanabe becomes President. Suzuo Watanabe becomes Chairman. The production of PCD tooling begins.
- 1982** A new cold saw blade plant is completed. Production and sales of the ACE insert tooling system starts.
- 1985** The production capacity of the cold saw blade plant is expanded. The Head Office moves to Ohguchi-cho, where the Main Factory is located.



Kankichi Kamiya



Inside the factory in Rokuban-cho (1957)



Prayer for safety before construction of the Main Factory (Early 1960's)



20th Anniversary (1968)



Suzuo Watanabe

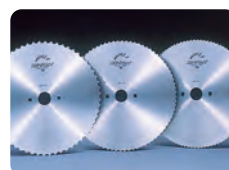

FM Cold Saw Blade

- 1986** P.T. Kanefusa Indonesia, the first offshore production facility, is established in Jakarta, Indonesia. An office in Singapore is set up.
- 1990** Kanefusa Hamono Ltd. and Kanefusa Knife and Saw Co., Ltd. merge to become KANEFUSA CORPORATION. A new T.C.T. saw blade production site is completed.
- 1995** Kanefusa Corporation is listed at the Nagoya Stock Exchange, Second Section. The production capacity of P.T. Kanefusa Indonesia is sharply increased.
- 1996** The new Technical Center for comprehensive Research and Development is completed.
- 1998** A liaison office in Eindhoven, The Netherlands, is set up.
- 1999** Kanefusa U.S.A. is established. Kanefusa Head Office and factory receive ISO 9001 certification.
- 2000** Masato Watanabe becomes President. Hiroshi Watanabe becomes Chairman.
- 2001** Kanefusa EUROPE B.V. is founded in Eindhoven, The Netherlands.
- 2002** Kanefusa China Corporation, the second offshore production facility, is established in Kunshan city, near Shanghai.
- 2003** Kunshan Kanefusa Corporation is set up. Kanefusa Head Office and Factory receive ISO 14001 certification.
- 2004** Kanefusa China Corporation receives ISO 9001 certification. The office in Singapore moves to Kuala Lumpur, Malaysia. A liaison office in Germany, which is under the jurisdiction of Kanefusa Europe B.V., is established. P.T. Kanefusa Indonesia receives ISO 9001 certification.
- 2005** Kanefusa China Corporation receives ISO 14001 certification.
- 2006** Kanefusa Corporation is listed at the Tokyo Stock Exchange, second Section. Kunshan Kanefusa Corporation acquires sales rights in China.
- 2008** Kanefusa Corporation celebrates its 60th anniversary of the establishment.
- 2009** Kanefusa India Pvt.Ltd. is established in India.
- 2010** Kanefusa Do Brasil LTDA. is established in Brasil.
- 2011** Kanefusa China Corporation merged Kunshan Kanefusa Corporation
- 2012** 「Kanefusa U.S.A.」 New office and service building is completed



Outside view of KFI (1986)



R&D Technical Center (1996)



Ceremony of the 60th Anniversary (2008)



Hiroshi Watanabe



Masato Watanabe

Saw Blade Technology	151
Thin Sawing Technology (TST)	152
Advanced Material Technology	153
PCD Fusion Technology (V-tech)	154
TAF-C Finger Joint Knives	155



General Technical Information	156
Cutting Edge Materials	160
Saw Blade Specifications	161
Tooth Geometries	162

Saw Blade Technology

Kanefusa Original Technology

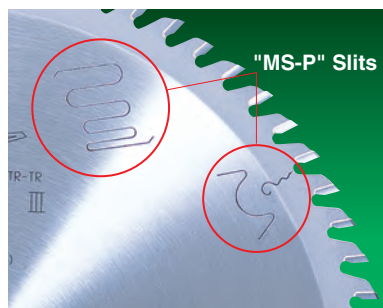

All Kanefusa saw blades are engineered to the absolute highest engineering standards. We believe in "Kaizen" and continuously innovate saw blade design, saw blade components, manufacturing technologies and quality control standards to achieve one goal. Higher user value.

User Value

- Less noise or cutting dust, for a better and safer work environment.
- Better performance for more machine uptime and less grinding cost.
- Constant and repeatable performance for a stable manufacturing process.
- Better cut quality for better products.
- Better recovery rates for higher material utilization.

Our saw blades outlast and outperform the conventional and offer more value than the conventional.

Satisfied customers attest to the reliable performance of Kanefusa saw blades worldwide.

Features for Reliable Performance

- Kanefusa uses only the very best steel for its saw blades. After heat treatment, the saw plate is very flat. Kanefusa's proprietary flattening and surface grinding processes ensure plates that are distortion free and have uniform thickness. A good plate with high stiffness is essential for straight running of the saw.
- Kanefusa Board Pro series have polymer injected vibration damping elements incorporated into the plate.

Vibrations are responsible for

- high tone noise which causes hardness of hearing which is identified as one of the most common occupational diseases in woodworking and irreparable.
- bad performance, due to structural damages to the carbide grain.
- bad cut quality because of edge chipping or a waving cut.

- Special carbide, which is exclusively available to Kanefusa, was developed in cooperation with a leading carbide manufacturer. The carbide was designed for cutting of board materials and clearly outlasts conventional carbides.
- The Kanefusa grinding process is a painstaking one. Each tooth is perfectly honed. Proprietary cooling methods assist with creating mirror-like finishes on the carbide teeth, that guarantees perfect cut finishes.

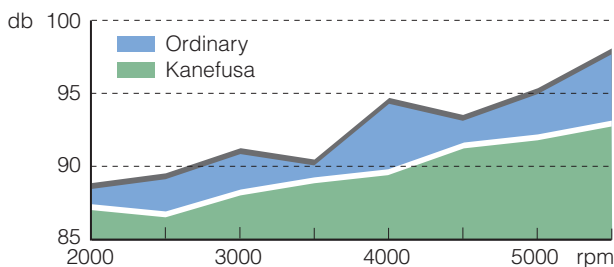

Noise comparison between a Kanefusa Board Pro saw blade and an ordinary saw blade

Thin Sawing Technology

Kanefusa Original Technology



Kanefusa's proprietary flattening and surface grinding methods ensure plates are distortion free and have a uniform thickness.

In addition to these features, after years of research, we have developed a laser slot pattern that allows reduction of the plate thickness, without compromising its lateral rigidity and ability to run straight. Polymers are injected into the laser slots and this reduces the vibration that causes high tone noise, structural damage of the carbide grain and a waving cut.

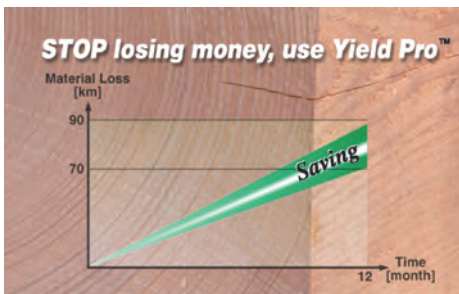

On average the kerf of a Yield Pro saw blade is 20% thinner compared to regular saw blades. This also creates less cutting pressure, which relates to better material recovery rates, cut surface quality, noise and tool life. Yield Pro saw blades are used on optimizing saws or cut off saws to cut solid timber.

Dimensions

	Yield Pro	Conventional	
D [mm]	Saw Blade Kerf [mm]	Saw Blade Kerf [mm]	Difference [%]
300	2.6	3.2	18.8
350	2.8	3.5	20.0
400	3.0	4.0	25.0
450	3.2	4.4	27.3
500	3.4	4.4	22.7
550	4.0	4.8	16.7
600	4.2	5.2	19.2

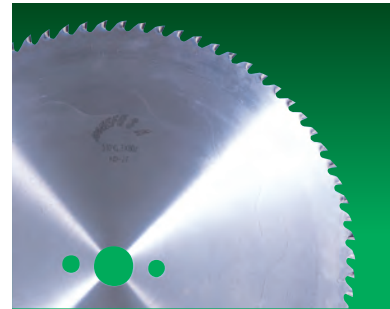

User Value

- Significant annual material savings.
- Better cut quality since a thinner kerf generates less cutting pressure which greatly reduces the grain tear-out.
- Enables you to run consistently faster cycle

Calculation example:

Kerf reduction = 0.7 mm.
 Material = Softwood
 50 cycle/min. = 3.5 cm fiber saving/min.
 Effective working hours per day = 6
 Effective working days per year = 250

Annual fiber saving = 3150 m

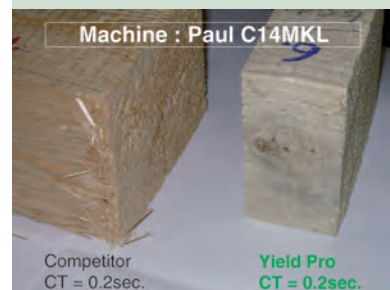

Advanced Material Technology

Kanefusa Original Technology



PAT.EP0739697

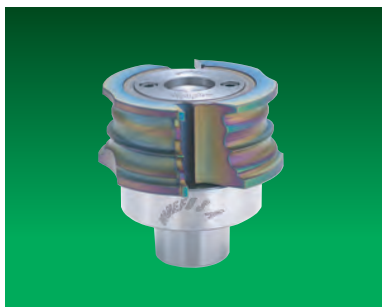

User Value

- 3-15 times longer edge life depending on the application leads to a better machine utilization for more output and less grinding cost due to less regrinds per year
- Smooth and tear-out free cut surface
- Reduction of manufacturing costs due to higher process stability and significant lower rejection rates due to torn grain and other defects
- Due to less residue adhesion, permanent higher feed speed can be realized
- Tools run quieter and power consumption does not increase significantly during run time

Kanefusa is the pioneer and worldwide leader in the development of advanced cutting edge materials for the wood working industry.

The first product treated with Advanced Material Technology where ST-1 planer knives, which we started selling in 1995.

Today we have two treatments for different substrate materials.

HS-HP is applied to cutting edges with a High Speed Steel substrate.

HC-UP is applied to cutting edges with a Tungsten Carbide base.

Both treatments change the wear characteristics of cutting edges. The result are extensively longer edge life and outstanding surface finishes when machining solid wood. Tools treated with advanced material technology can be re-sharpened multiple times with conventional grinding equipment.



HSS Knife



ST-1 Planer Knife

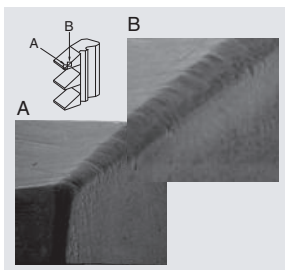

HSS Finger Joint Cutter

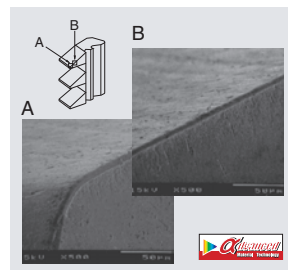

TAF-C Finger Joint Cutter

PCD Fusion Technology

Kanefusa Original Technology



Polycrystalline Diamond (PCD) is considerably harder and wear resistant than tungsten carbide enabling tremendous longer tool life. However, due to the brittleness of the PCD, the cutting edge geometry of a PCD saw blades is less aggressive compared to that of a Tungsten Carbide Tipped saw blade. In result, the cut quality is inferior to that of a T.C.T. saw blade.

We have developed a V-shaped rake side tooth geometry for PCD tipped saw blades, which cuts aggressive like a T.C.T. saw blade. In result the tool life is 30 to 40 times longer and the saw blades cuts tear out free laminated particleboard or MDF.



In order to manufacture such a tooth shape, it was necessary to invent a technology that allows fusing single PCD elements together. After years of research, we have successfully developed this technology. The first product available with two single pieces of PCD fused into a V-shaped tip is the V-tech PCD saw blade.

V-tech saw blades are very suitable for use on vertical panel saws and table saws to cut plastic or paper laminated MDF and particleboard.

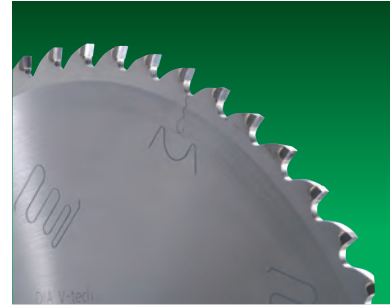

User Value

- Longer edge life than a T.C.T. saw blade and an excellent cut finish allows tremendous cost savings in the manufacturing process
- DIA V-tech saw blades can be re-sharpened several times
- Runs very straight because the cutting forces are in balance

TAF-C Finger Joint Knives

Kanefusa Original Technology



PAT.EP0739697, EP1043129, US6644896, CA2456953, CNZL02815463, EP1424176, US7424900

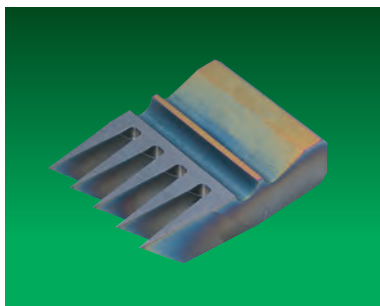

User Value

- 50% longer tool life than regular HP-treated finger joint cutters leads to better machine utilization and less grinds per year
- Less stock removal during grinding relates to faster grinding and a longer use life of the finger joint cutter
- Because the cutting edge stays sharp, the knife cuts cleaner, which relates to a truer cut profile

Chipping and rounding of the cutting edge of finger joint cutters leads to tremendous losses in machine run time, high grinding costs and excessive spending on new tooling.

The cutting edge is often a solid single layered material. At Kanefusa we have developed a multi-structured material that clearly outperforms ordinary tooling.

The multi-structure takes into account that the top and bottom finger are exposed to different forces and wear. The top of the cutter is made of a highly abrasion resistant High Speed Steel (HSS), which slows down the rounding process and minimizes chipping of the cutting edge.

The bottom is built from hard but flexible steel to reduce breakage of the fingers due to excessive cutting forces. This structure is built on an alloy steel substrate with a high shock resistance.

TAF-C finger jointing knives (inserts) are used to cut softwood in the production of engineered wood with a length of 15/15, 15/16.5, 20/20 and 20/22 mm.

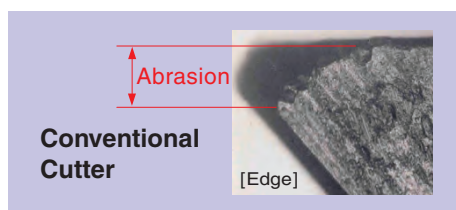
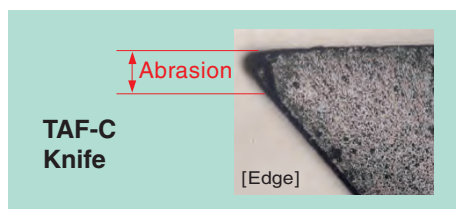
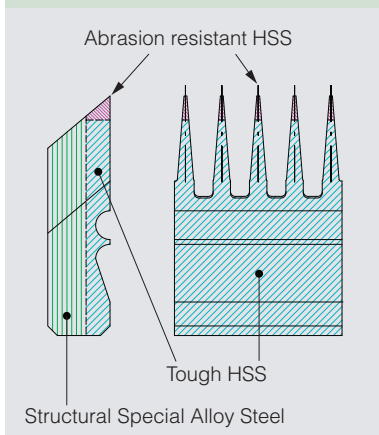

General Technical Information

Cutting with grain leaves a smooth surface.

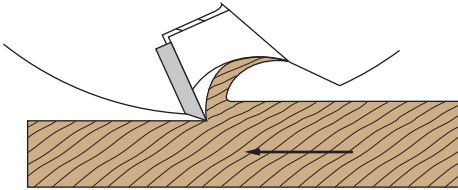

Cutting across grain is easily done but leaves a rough finish.

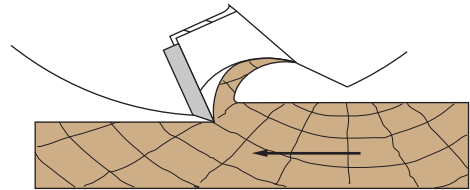

Cutting against grain gives a raw surface due to pre-splitting of the wood in front of the cutting edge.

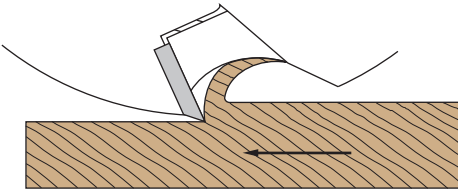

Cutting end grain requires most horsepower and gives rough finish.

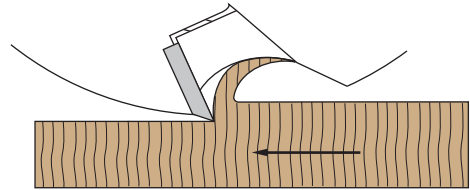

Abrasive Cutting / Cutting against the feed

In abrasive cutting the cutting edge motion is against the feed direction of the material. The cutting edge enters into the work piece shaving and pushing. The cutting process creates a long chip with increasing thickness. The direction of the cutting force is up from the table, trying to lift up the work piece. Especially when machining against the grain, tear-outs are inevitable.

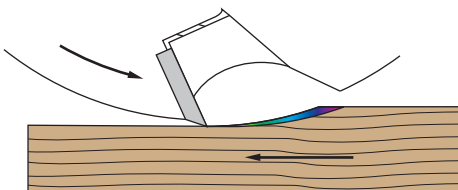

Climb Cutting / Cutting with the feed

In climb cutting the cutting edge motion is with the feed direction of the material. The cutting edge enters into the work piece. The cutting process creates a short chip with decreasing thickness. The direction of the cutting forces are into the material and pre-splitting of the grain is omitted. Smooth surface even when machining against the grain can be achieved.

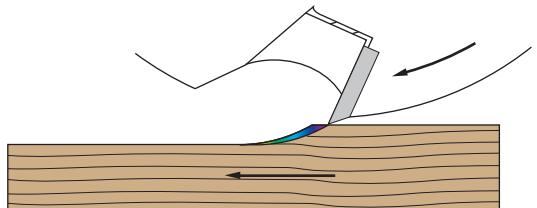

General Technical Information

Cutting Speed V_c

The cutting speed is the velocity of the blade at its outmost diameter. It is an important performance characteristic of tooling. The cutting speed of the tool should match material cut. The cutting speed can be manipulated by changing the spindle speed or outer tool diameter.

$$V_c = \frac{D \times \pi \times n}{1000 \times 60} \text{ [m/s]}$$

D = Outer tool diameter [mm]

π = Pi (3.141592...)

n = Spindle speed [RPM]

Recommended cutting speeds [m/s]

Type of tool	Cutter	Saw Blades
Cutting edge material	HS-HP, HC-UP HW, DP	HW, HC-UP DP
Softwood	60 - 90	70 - 100
Hardwood	50 - 90	70 - 90
Particleboard, MDF	60 - 90	60 - 90
Laminated boards	40 - 70	60 - 100

Chipload S_z

The chipload is another important performance characteristic. It describes the feed rate per tooth. In a simplified way, the feed rate per tooth is used to describe the cut quality. The feed rate, number of teeth and spindle speed can manipulate the feed per tooth and therefore also the cut quality. In actual situation, the obtained surface is a one-knife finish, since there are many tolerances in the machine, tool and interface, that don't allow running all teeth on the exact same cut circle. Hydro sleeves and jointing enable to reduce the difference between the max and min swing of the knives of a cutter enabling a better cut finish or to run higher feed rates.

$$S_z = \frac{v_f \times 1000}{n \times z} \text{ [mm]}$$

v_f = Feed rate [m/min]

Z = Number of teeth

n = Spindle speed [RPM]

Recommended chiploads [mm]

Type of tool	Cutter	Saw Blades
Solid wood along the grain	0.6 - 2.5	0.2 - 1.5
Solid wood across the grain	0.3 - 0.8	0.1 - 0.2
Particleboard, MDF	0.8 - 1.5	0.05 - 0.2
Plastic laminated board	0.6 - 1.2	0.03 - 0.06

General Technical Information

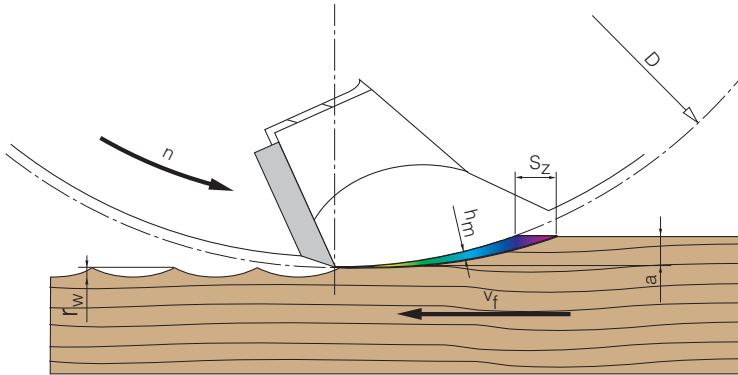

Cutting Arc Depth

$$r_w = \frac{S_z^2}{4 \times D} \text{ [mm]}$$

S_z = Chipload [mm]

D = Outer tool diameter [mm]

Average Chip Thickness h_m

$$h_m = S_z \times \sqrt{\frac{a}{D}} \text{ [mm]}$$

S_z = Chipload [mm]

D = Outer tool diameter [mm]

a = Cutting depth [mm]

Number of Teeth in the Cut

As a rule of the thumb, in case of a saw blade, there should be not more or less than 2-4 teeth at the same time in the material.

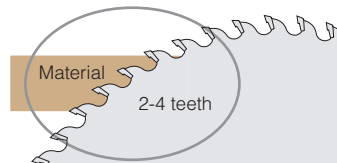

Tooth Pitch & Number of Teeth

$$t = \frac{h \times 1.45}{k} \text{ [mm]}$$

t = Tooth pitch [mm]

h = Thickness of the material

k = Number of teeth in cut

$$Z = \frac{D \times \pi}{t}$$

z = Number of teeth

t = Tooth pitch [mm]

D = Outer diameter of the saw blade [mm]

π = Pi (3.141592)

General Technical Information

Clockwise rotation

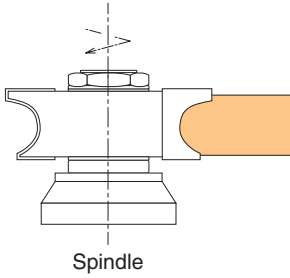

Counterclockwise rotation

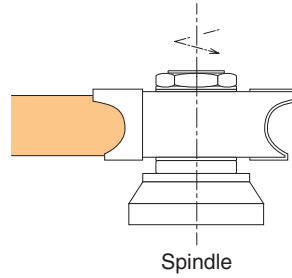

Clockwise rotation

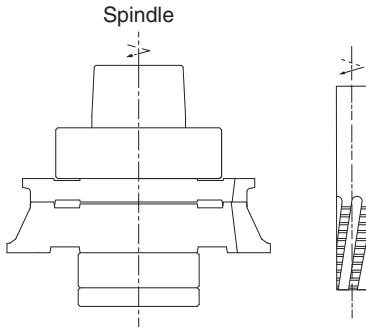

Counterclockwise rotation

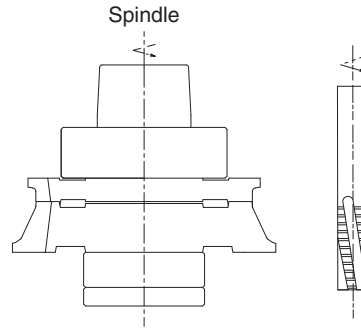

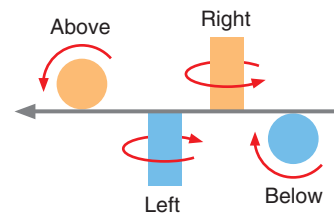
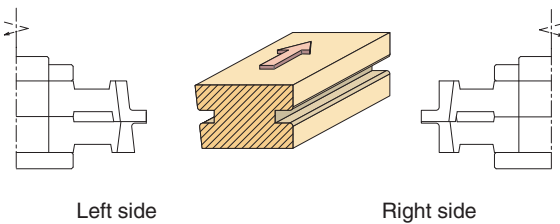

Tool Position

The position of the spindle is always defined from the in-feed side of the machine.



Cutting Edge Materials

Abbreviation	Material	Area of Application	Kanefusa' s Product Range
DM	Single Crystal Diamond (MCD)	Laminate flooring Machining plastics like PMMA	Custom made tooling
DP	Polycrystalline Diamond (PCD)	Various flooring materials Panel based furniture Cement-fiber board Various plastics Non-ferrous metals	Board Pro DIA saw blades DIA-Vtech saw blades Cosmobit router bits Cutters Routers
HC-UP 	Advanced Material Technology treated Tungsten Carbide	Solid wood based products such as - Furniture and chairs - Stairs and windows - Structural lumber	SF-saw blades E-Bit router bits Finger joint cutters Profile cutters and routers
HW	Tungsten Carbide	Panel based products Solid wood products Non-ferrous metals Various plastics	Board Pro saw blades Timber Max saw blades Sash Pro saw blades Yield Pro saw blades
HS-HP 	Advanced Material Technology treated High Speed Steel	Planing, profiling and finger jointing of solid wood	ST-1 knives ENSHIN knives Finger Joint Cutters
HS	High Speed Steel (HSS)	Veneer and chip production	Industrial knives
HL	Alloy Steel	Veneer and chip production	Timber Tec Knives Industrial knives
SP	Tool Steel	Veneer and chip production	Industrial knives

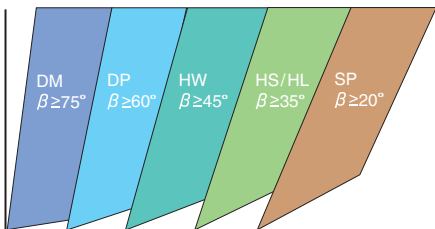

Suitable edge angle [β] according to cutting edge material

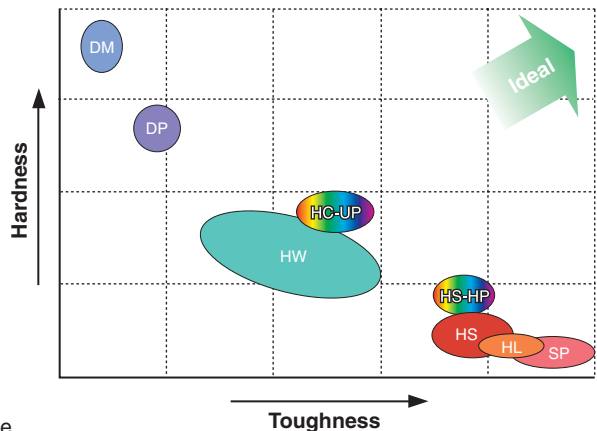

Saw Blade Specifications

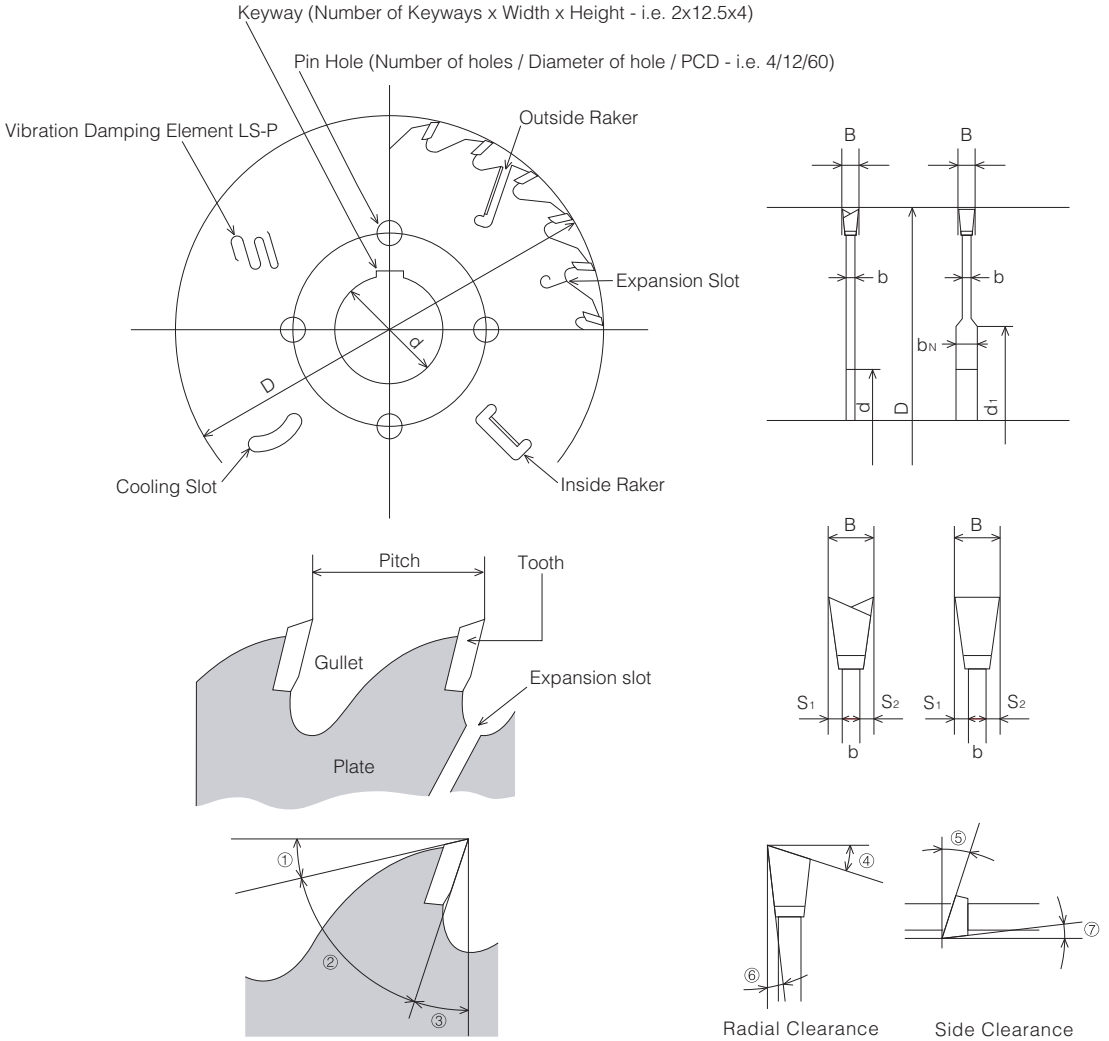



Angle Designation

- ① Clearance Angle [α]
- ② Included Angle [β]
- ③ Hook Angle [γ]
- ④ Top Bevel Angle [ϵ]
- ⑤ Face Bevel Angle [λ]
- ⑥ Radial Clearance Angle [α_r]
- ⑦ Tangential Clearance Angle [α_t]

Diameter	D
Bore	d
Hub Diameter	d_1
Kerf	B
Plate Thickness	b
Hub Thickness	b_N
Number of Teeth	z
Side Clearance	S_1, S_2

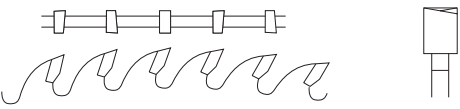
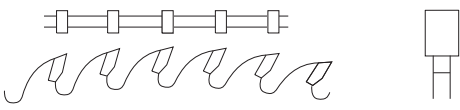
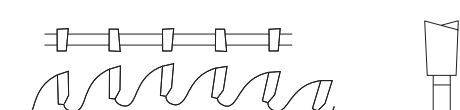
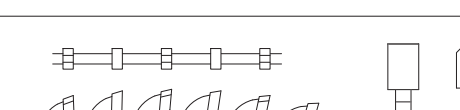
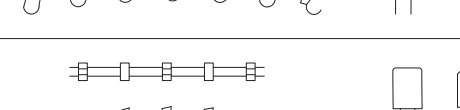
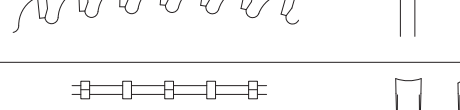
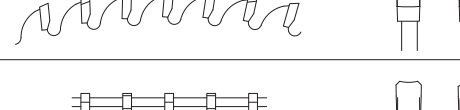
Tooth Geometries

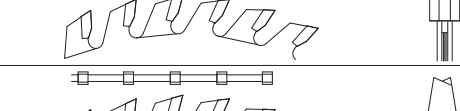
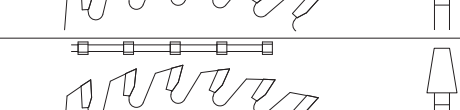
	Abbreviation	Description
	A-type	Alternate top bevel with raker Used on vertical panel saws to cut various panel materials, plywood etc. Very aggressive
	B-type	Flat tooth Used for ripping solid wood
	BC-type	Alternate Top Bevel Used for cutting solid wood across and along the grain, raw panels, paper or veneer laminated panels, thin wall extruded material
	D-type	Triple chip tooth alternating with flat tooth Used for cutting of plastic laminated panel material, various plastics and non-ferrous metals
	TD-type	Triple chip tooth with additional chamfer on the flat tooth Used for finish cutting of plastic laminated particleboard and MDF on beam saws
	DH-type	Hollow face tooth (flat tooth alternates with inverted V tooth) Used for cutting paper, foil or veneer laminated panel materials
	DHC-type	Hollow face tooth (flat tooth with chamfer alternates with inverted V tooth) Used for cutting of plastic laminated panel materials
	CA-type	Split design (one side bevel) Scoring saw blade that cuts very aggressive
	TP-type	Conical tooth with alternative bevel Multipurpose conical type scoring saw blade.
	F-type	Conical flat tooth Conical type scoring saw blade to cut plastic laminated panels



<http://www.kanefusa.net>

KANEFUSA CORPORATION

Head Office / Factory

1-1 Nakaoguchi, Ohguchi-cho, Niwa-Gun
Aichi-ken, Japan, Postal Code 480-0192
Tel : +81 587 95 7221
Fax : +81 587 95 7226
E-mail: sales-ex@kanefusa.co.jp

PT. KANEFUSA INDONESIA

EJIP Industrial Park, Plot 8D, Cikarang Selatan,
Bekasi 17550, West Java, Indonesia
Tel : +62 21 897 0360
Fax: +62 21 897 0286
+62 21 897 0287
E-mail : sales@kanefusa.co.id

KANEFUSA EUROPE B.V.

De Witbogt 12, 5652 AG, Eindhoven, The Netherlands
Tel : +31 40 2900901
Fax: +31 40 2900908
E-mail : info@kanefusa.nl

KANEFUSA USA, INC.

621 Dolwick Drive, Erlanger, KY 41018, USA
Tel : +1 859 283 1450
Fax: +1 859 283 5256
E-mail : sales@kanefusa-na.com

KANEFUSA CHINA CORPORATION

NO.50 Zhuzhu Road, Lujia Town Kunshan city, Jiangsu, China
Tel : +86 512 57875072
Fax: +86 512 57875073
E-mail : yy@kanefusa-cn.com

TIANJIN OFFICE

Sanjinglu No.5 Dongli economic development zone Tianjin city CHINA
Tel : +86 22 5823 7633
Fax: +86 22 5823 7632
E-mail : tjkc03@kanefusa-cn.com

KANEFUSA INDIA PRIVATE LIMITED

Plot No.232, Sector-8, IMT Manesar, Gurgaon,
Haryana PIN 122-050 India
Tel : +91 124 420 8440
Fax: +91 124 420 8441
E-mail : info@kanefusa.co.in

KANEFUSA DO BRASIL LTDA.

Rua Joaquim de Almeida,75,Sao Paulo,SP,Brasil,CEP04050-010
Tel : +55 11 2372 7664
Fax: +55 11 2372 7663
E-mail : vendas@kanefusa.net.br

MALAYSIA OFFICE

Suite 839 Level 8, Pavilion KL 168 Jalan Bukit Bintang
55100 Kuala Lumpur, Malaysia
Tel : +60 3 92057721
Fax: +60 3 92057720
E-mail : kanefusamal@myjaring.net
